

PCM-9387

**Celeron[®] M 3.5" SBC with
PCI-104/VGA/LCD/LVDS Ether-
net/USB2.0 and SSD**

User Manual

Copyright

This document is copyrighted, © 2006. All rights are reserved. The original manufacturer reserves the right to make improvements to the products described in this manual at any time without notice.

No part of this manual may be reproduced, copied, translated or transmitted in any form or by any means without the prior written permission of the original manufacturer. Information provided in this manual is intended to be accurate and reliable. However, the original manufacturer assumes no responsibility for its use, nor for any infringements upon the rights of third parties that may result from such use.

Acknowledgements

Award is a trademark of Award Software International, Inc.

VIA is a trademark of VIA Technologies, Inc.

IBM, PC/AT, PS/2 and VGA are trademarks of International Business Machines Corporation.

Intel, Pentium, Celeron, and MMX are registered trademarks of Intel Corporation.

Microsoft Windows[®] is a registered trademark of Microsoft Corp.

RTL is a trademark of Realtek Semi-Conductor Co., Ltd.

ESS is a trademark of ESS Technology, Inc.

UMC is a trademark of United Microelectronics Corporation.

SMI is a trademark of Silicon Motion, Inc.

Creative is a trademark of Creative Technology LTD.

All other product names or trademarks are properties of their respective owners.

For more information on this and other Advantech products, please visit our websites at: **<http://www.advantech.com>**

<http://www.advantech.com/eplatform>

For technical support and service, please visit our support website at:

<http://www.advantech.com/support>

This manual is for the PCM-9387.

Part No. 2006938712

3rd Edition

Printed in Taiwan

Nov. 2006

Packing List

Before you begin installing your card, please make sure that the following materials have been shipped:

- 1 PCM-9387 SBC
- 1 Startup manual
- 1 Utility CD
- 1 mini jumper pack p/n: 9689000002
- 1 Audio cable p/n: 1703100152
- 1 IDE 44 pin cable p/n: 1701440351
- 1 USB 2 port Cable p/n: 1703100121
- 1 Parallel port cable p/n: 1700260250
- 1 Keyboard/Mouse cable p/n: 1700060202
- 1 embedded COM port cable p/n: 1701140201
- 1 ATX power cable 20P-12P cable p/n: 1700000265

If any of these items are missing or damaged, contact your distributor or sales representative immediately.

Model No. List Description

- **PCM-9387F-M0A2E** 3.5" SBC with ULV Celeron M 600 (0 L2), VGA, LVDS, DVI, LAN, USB
- **PCM-9387F-S0A2E** 3.5" SBC with ULV Celeron M 1.0GHz (0 L2), VGA, LVDS, DVI, LAN, USB

Additional Information and Assistance

1. Visit the Advantech web site at **www.advantech.com** where you can find the latest information about the product.
2. Contact your distributor, sales representative, or Advantech's customer service center for technical support if you need additional assistance.

Please have the following information ready before you call:

- Product name and serial number
- Description of your peripheral attachments
- Description of your software (operating system, version, application software, etc.)
- A complete description of the problem
- The exact wording of any error messages

FCC

This device complies with the requirements in part 15 of the FCC rules: Operation is subject to the following two conditions:

- 1. This device may not cause harmful interference, and*
- 2. This device must accept any interference received, including interference that may cause undesired operation*

This equipment has been tested and found to comply with the limits for a Class A digital device, pursuant to Part 15 of the FCC Rules. These limits are designed to provide reasonable protection against harmful interference when the equipment is operated in a commercial environment. This equipment generates, uses, and can radiate radio frequency energy and, if not installed and used in accordance with the instruction manual, may cause harmful interference to radio communications. Operation of this device in a residential area is likely to cause harmful interference in which case the user will be required to correct the interference at his/her own expense. The user is advised that any equipment changes or modifications not expressly approved by the party responsible for compliance would void the compliance to FCC regulations and therefore, the user's authority to operate the equipment.

Caution!



Achtung!

There is a danger of a new battery exploding if it is incorrectly installed. Do not attempt to recharge, force open, or heat the battery. Replace the battery only with the same or equivalent type recommended by the manufacturer. Discard used batteries according to the manufacturer's instructions

Contents

Chapter 1	Introduction	2
1.1	Introduction	2
1.2	Features	2
1.3	Specifications	3
1.3.1	Standard 3.5" Biscuit SBC Functions	3
1.3.2	VGA/LVDS Interface	3
1.3.3	Ethernet Interface	4
1.3.4	Audio Function	4
1.3.5	Mechanical and Environmental	4
1.4	Board layout: dimensions	5
	Figure 1.1:Board layout: Dimensions (Component Side)	5
	Figure 1.2:Board layout: Dimensions (Solder Side).....	6
Chapter 2	Installation	8
2.1	Jumpers.....	8
2.1.1	Jumper Location	8
	Table 2.1:Jumpers.....	8
2.1.2	Jumper Settings.....	9
	Table 2.2:Audio Power Selector(J1).....	9
	Table 2.3:COM2 Setting.....	9
	Table 2.4:LCD Power Setting (J6)	9
	Table 2.5:AT/ATX Power Setting (J8).....	9
	Table 2.6:PCI VIO (JP1)	10
	Table 2.7:CMOS clear	10
2.2	Connectors.....	11
	Table 2.8:Connectors	11
2.3	Locating Connectors	12
	Figure 2.1:Jumpers and Connectors Drawing (component side).....	12
	Figure 2.2:Connectors (solder side).....	12
2.4	Setting Jumpers	17
2.5	Installing SO-DIMM	18
2.6	IDE, CDROM hard drive connector (CN6)	18
2.6.1	Connecting the hard drive	19
2.7	Solid State Disk	19
2.7.1	CompactFlash (CN21)	19
2.8	Parallel port connector (CN13)	19
2.9	Keyboard and PS/2 mouse connector (CN14)	20
2.10	Power & HDD LED Connector (CN10)	20
2.10.1	Power & HDD LED Connector (CN10).....	20

	2.10.2	Power Reset button (S2)	20
2.11		Power connectors (CN3)	20
	2.11.1	Main power connector, +5 V, +12 V (CN3).....	20
	2.11.2	Fan power supply connector (CN15).....	20
2.12		Audio interfaces (CN2)	20
	2.12.1	Audio connector (CN2)	20
2.13		COM port connector (CN8,CN19).....	21
	2.13.1	COM2 RS-232/422/485 setting (J2)	21
		Table 2.9: J2: COM2 Setting	21
2.14		VGA/LCD/LVDS interface connections	21
	2.14.1	CRT display connector (CN18).....	21
	2.14.2	LVDS LCD panel connector (CN1)	21
2.15		Ethernet configuration	21
	2.15.1	100Base-T/1000Base-T connector (CN12)	22
	2.15.2	Network boot (Depends on Ethernet Controller).....	22
2.16		Watchdog timer configuration	22
2.17		USB connectors (CN5,CN9).....	22
2.18		GPIO (General Purpose Input Output) (CN7).....	23
2.19		SMBus connector (default); SIR (optional) (CN11)	23
	2.19.1	SMBus	23
	2.19.2	SIR	23
2.20		Extending signals for PCI-ISA bridge (CN24)	23
Chapter	3	Chipset Software Installation Utility	26
	3.1	Before you begin	26
	3.2	Introduction	26
	3.3	Installing the CSI Utility	27
Chapter	4	Award BIOS Setup.....	32
	4.1	Introduction	32
	4.1.1	CMOS RAM Auto-backup and Restore	32
	4.2	Entering Setup.....	33
		Figure 4.1: Award BIOS Setup initial screen	33
	4.3	Standard CMOS Setup	34
		Figure 4.2: Standard CMOS features screen	34
	4.4	Advanced BIOS Features	35
		Figure 4.3: Advanced BIOS features screen.....	35
	4.4.1	Virus Warning.....	35
	4.4.2	L1 & L2 Cache	35
	4.4.3	Quick Power On Self Test	35
	4.4.4	First/Second/Third/Other Boot Device.....	36
	4.4.5	Swap Floppy Drive	36
	4.4.6	Boot UP Floppy Seek	36
	4.4.7	Boot Up NumLock Status.....	36
	4.4.8	Gate A20 Option.....	36

4.4.9	Typematic Rate Setting.....	36
4.4.10	Typematic Rate (Chars/Sec).....	36
4.4.11	Typematic Delay (msec).....	36
4.4.12	Security Option.....	36
4.4.13	APIC Mode.....	37
4.4.14	MPS Version Control For OS.....	37
4.5	Integrated Peripherals.....	37
4.5.1	IDE Master/Slave PIO/UDMA Mode.....	37
4.5.2	On-Chip Secondary PCI IDE.....	38
	Figure 4.4: Integrated peripherals.....	38
4.5.3	USB Controller.....	38
4.5.4	USB Keyboard/Mouse Support.....	38
4.5.5	AC97 Audio.....	38
4.5.6	Init Display First.....	38
4.5.7	Onboard LAN Controller.....	38
4.5.8	IDE HDD Block Mode.....	39
4.5.9	Onboard FDC Controller.....	39
4.5.10	Onboard Serial Port.....	39
4.5.11	UART Mode Select.....	39
4.5.12	RxD, TxD Active.....	39
4.5.13	IR Transmission Delay.....	39
4.5.14	UR2 Duplex Mode.....	39
4.5.15	Onboard Parallel Port.....	39
4.5.16	Parallel Port Mode.....	39
4.5.17	EPP Mode Select.....	40
4.5.18	ECP Mode Use DMA.....	40
4.6	Power Management Setup.....	40
	Figure 4.5: Power management setup screen.....	40
4.6.1	Power-Supply Type.....	40
4.6.2	ACPI function.....	40
4.6.3	Power Management.....	41
4.6.4	Video Off In Suspend.....	41
4.6.5	Modem Use IRQ.....	41
4.6.6	HDD Power Down.....	41
4.6.7	Soft-Off by PWR-BTTN.....	41
4.6.8	CPU THRM-Throttling.....	41
4.6.9	PowerOn By LAN.....	41
4.6.10	PowerOn By Modem.....	42
4.6.11	PowerOn By Alarm.....	42
4.6.12	Primary IDE 0 (1) and Secondary IDE 0 (1).....	42
4.6.13	FDD, COM, LPT PORT.....	42
4.6.14	PCI PIRQ [A-D]#.....	42
4.7	PnP/PCI Configurations.....	43
4.7.1	PnP OS Installed.....	43
	Figure 4.6: PnP/PCI configurations screen.....	43

	4.7.2	Reset Configuration Data.....	43
	4.7.3	Resources controlled by.....	43
	4.7.4	PCI/VGA Palette Snoop	43
	4.8	Password Setting	44
	4.9	Save & Exit Setup	44
	4.10	Exit Without Saving.....	45
Chapter	5	PCI SVGA/LCD Setup	48
	5.1	Introduction	48
	5.1.1	CMOS setting for panel type	48
	5.1.2	Display type.....	48
	5.1.3	Dual Independent Display	48
	5.2	Connections to Two Standard LCDs.....	50
	5.2.1	LG LM 150x06 (1024x768 LVDS LCD).....	50
		Table 5.1:Connections to LCD/Flat Panel (CN1).....	50
	5.2.2	AU M170EG01 (1280x1024 TFT LCD @ 48bit).....	51
		Table 5.2:Connections to AU M170EG01 (CN1).....	51
	5.3	Installation of the SVGA Driver	52
	5.3.1	Installation of Windows 98/2000.....	52
	5.4	Further Information	55
Chapter	6	Audio Setup.....	58
	6.1	Introduction	58
	6.2	Driver installation.....	58
	6.2.1	Before you begin.....	58
	6.2.2	Windows 98 drivers.....	59
Chapter	7	Ethernet Interface	62
	7.1	Introduction	62
	7.2	Installation of Ethernet driver	62
	7.2.1	Installation for Windows 98	62
	7.2.2	Installation for Windows 2000	66
	7.3	Further information	71
Appendix A		Programming GPIO & Watchdog Timer	74
	A.1	Supported GPIO Register.....	74
	A.1.1	GPIO Registers	74
	A.1.2	GPIO Example program-1	75
	A.2	Watchdog programming.....	77
Appendix B		Pin Assignments	80
	B.1	CPU Fan Power Connector (CN15).....	80
		Table B.1:CPU Fan Power connector (CN15).....	80
	B.2	Audio Connector (CN2).....	80
		Table B.2:Audio connector (CN2).....	80
	B.3	Main Power Connector (CN3)	81
		Table B.3:Main Power Connector (CN3).....	81

B.4	Keyboard and PS/2 Mouse Connector (CN14).....	81
	Table B.4:Keyboard and mouse connector (CN14).....	81
B.5	IDE Hard Drive Connector (CN6)	82
	Table B.5:IDE HDD connector (CN6)	82
B.6	Parallel Port Connector (CN13)	83
	Table B.6:Parallel Port Connector (CN13).....	83
B.7	Power & HDD LED Connector (CN10)	84
	Table B.7:Power & HDD LED Connector (CN10).....	84
B.8	USB Connector (CN5)	84
	Table B.8:USB connector (CN5).....	84
B.9	LCD Inverter Power Connector (CN17)	85
	Table B.9:LCD Inverter Power Conn. (CN17).....	85
B.10	LVDS Connector (CN1).....	86
	Table B.10:LVDS Connector (CN1)	86
B.11	COM2 RS232/422/485 series port (CN8).....	87
	Table B.11:COM2 RS-232/422/485 series port	87
	B.11.1 CN8, COM2 RS 422/485 - transfer to 2nd internal RS-232	
	87
	B.11.2 CN8, 2nd internal RS-232 - transfer to COM2 RS-422/	
	485.....	87
B.12	CompactFlash Card Connector (CN21)	88
	Table B.12:CompactFlash Card Connector (CN21).....	88
B.13	SMBus Connector (default); IrDA (optional) (CN11)	89
	Table B.13:SMBUS connector (Default); IrDA connector	
	(Optional) (CN11).....	89
B.14	DVI Connector (CN23).....	89
	Table B.14:DVI connector (CN23)	89
B.15	GPIO Connector (CN7).....	90
	Table B.15:GPIO connector (CN7)	90
B.16	USB2 Connector(CN9)	90
	Table B.16:USB2 Connector (CN9).....	90
B.17	Print Port Connector(CN13).....	91
	Table B.17:Print Port Connector (CN13)	91
B.18	Extending signals for PCI-ISA bridge Connector(CN24).	
	91
	Table B.18:Extending signals for PCI-ISA bridge Con-	
	nector (CN24).....	91

Appendix C System Assignments 94

C.1	System I/O Ports.....	94
	Table C.1:System I/O ports	94
C.2	1st MB memory map.....	95
	Table C.2:1st MB memory map	95
C.3	DMA channel assignments.....	96

	Table C.3:DMA channel assignments	96
C.4	Interrupt assignments	97
	Table C.4:Interrupt assignments	97
Appendix D	AT/ATX Power setting	100
D.1	Introduction	100
	Table D.1:Power Connector	100
Appendix E	Optional Kit	104
E.1	Embedded OS.....	104
E.2	Optional Kit.....	104
E.3	Assembly for CPU and cooling for PCM-9380, uFCPGA type CPU, please follow the following assembly information	104
Appendix F	Mechanical Drawings.....	108
F.1	Mechanical Drawings.....	108
	Figure F.1:PCM-9387 Mech Drawing (Component) .	108
	Figure F.2:PCM-9387 Mech Drawing (Solder Side)..	109

General Information

This chapter gives background information on the PCM-9387.

Sections include:

- Introduction
- Features
- Specifications
- Board layout and dimensions

Chapter 1 Introduction

1.1 Introduction

The PCM-9387 is a 3.5" SBC (Single Board Computing) with a high performance and lower power based on Celeron M processors.

The PCM-9387, in conjunction with Intel 852GM chipset and Intel CPU Celeron M 600MHz (with 0 L2 cache) or Celeron M 1.0 GHz (with 512K L2 cache), supports three USB 2.0 compatible ports, a PCI Fast or Gigabit Ethernet interface, 2 Channel LVDS interface, and one PCI-104 expansion connector, and accommodate up to 1GB of DDR RAM memory.

The PCM-9387's board can be easier stacking on series PCI-104 modules for different application market requirement.

1.2 Features

- Embedded Intel Celeron M Processor
- Supports DDR memory
- Supports 1000BASE-T Ethernet
- Supports 2 channel (2 x 18-bit) LVDS LCD display (2 x 24-bit optional)
- Supports 3 x USB 2.0 port
- Supports PCI-104 expansion

1.3 Specifications

1.3.1 Standard 3.5" Biscuit SBC Functions

- **CPU:** Embedded Intel ULV Celeron M 600 MHz (512k L2 cache)
Embedded Intel ULV Celeron M 1.0 GHz (0 L2 cache)
- **System Memory:** 1 x SODIMM socket, support Double Data Rate (DDR) 128 MB to 1GB, accept 128/256/512/1000 MB DDR200/266 DRAM
- **2nd Cache Memory:** Depends on CPU type from 0 to 512 KB
- **System Chipset:** Intel 852GM GMCH/ICH4 chipset
- **BIOS:** AWARD 4Mbit Flash BIOS
- **Watchdog timer:** 255 levels timer interval
- **Expansion Interface:** PCI-104
- **Battery:** Lithium 3V/196 mAH
- **Power management:** Supports power saving modes including Normal/Standby/Suspend modes. APM 1.2, ACPI compliant, wake on LAN, and modem ring-in functions
- **Enhanced IDE interface:** One channels supports up to four EIDE devices. BIOS auto-detect, PIO Mode 3 or Mode 4, supports UDMA 33 mode
- **Serial ports:** Two serial RS-232 ports, COM1: RS-232, COM2: RS-232/422/485 (2nd internal RS-232 optional)
- **Parallel port:** One parallel port, supports SPP/EPP/ECP mode
- **Keyboard/mouse connector:** Supports one standard PC/AT keyboard and a PS/2 mouse
- **Audio:** Supports AC97 Audio stereo sound
- **USB:** Three USB 2.0 compliant universal serial bus ports
- **Solid State Disk (SSD):** Supports one 50-pin socket for CFC type
- **IrDA:** 115kbps, SIR, IrDA 1.0 complaint (optional)
- **GPIO:** 4 bit general purpose Input / Output
- **SMBus:** System Management Bus for advanced monitoring / control interface

1.3.2 VGA/LVDS Interface

- **Chipset:** Intel 852GM Graphic Memory Control Hub (GMCH)
- **Memory Size:** Optimized Shared Memory Architecture, support 64MB frame buffer using system memory
- **Resolution:** CRT display Mode: pixel resolution up to 1600 x 1200 @85-Hz
- **TTL LCD:** optional, supported by PCM-3540R module
- **LVDS LCD:** up to UXGA panel resolution with frequency range from 25-MHz to 112-MHz

- **LVDS:** supports 2 channel (2 x 18-bit) LVDS LCD Panel (2 x 24-bit optional), 16:9 wide screen panel supported
- **Dual Independent Display:** supports CRT+LVDS/ CRT+DVI / LVDS + DVI

1.3.3 Ethernet Interface

- **Chipset supports:** Intel 82551QM (10/100Mbps) (with Wake on LAN) 10/100/1000Mbps - Intel 82541PI (Optional)
- **Interface:** RJ45 connector
- Standard IEEE 802.3 z/ab (1000BASE-T) or IEEE 802.3u (100 BASE-T) protocol compatible
- Built-in boot ROM

1.3.4 Audio Function

- **Chipset:** Intel 82801DB I/O Controller Hub 4 (ICH4) & ALC203 codec chipset
- **Audio controller:** Supports AC97 3D Audio stereo sound
- **Audio interface:** Microphone in, line in, line out

1.3.5 Mechanical and Environmental

- **Dimensions:** 145 x 102 mm (5.9"x 4.2")
Mechanical Drawing (dxf file) is available.
- **Power Supply Type:** AT/ATX
- **Power Requirement:** +5V $\pm 5\%$, +12V $\pm 5\%$ (Optional), +5V standby for ATX mode, or supports single +5 V power only
- **Power Consumption:**
ULV Celeron M 600 MHz @ 256 MB DDR266
Max (HCT): +5 V@ 2.0A, +12 V@ 0.02A
- **Operating temperature:** 0 ~ 60°C (32 ~ 140°F)
- **Operating Humidity:** 0% ~ 90% relative humidity, non-condensing
- **Weight:** 0.85 kg (reference weight of total package)

1.4 Board layout: dimensions

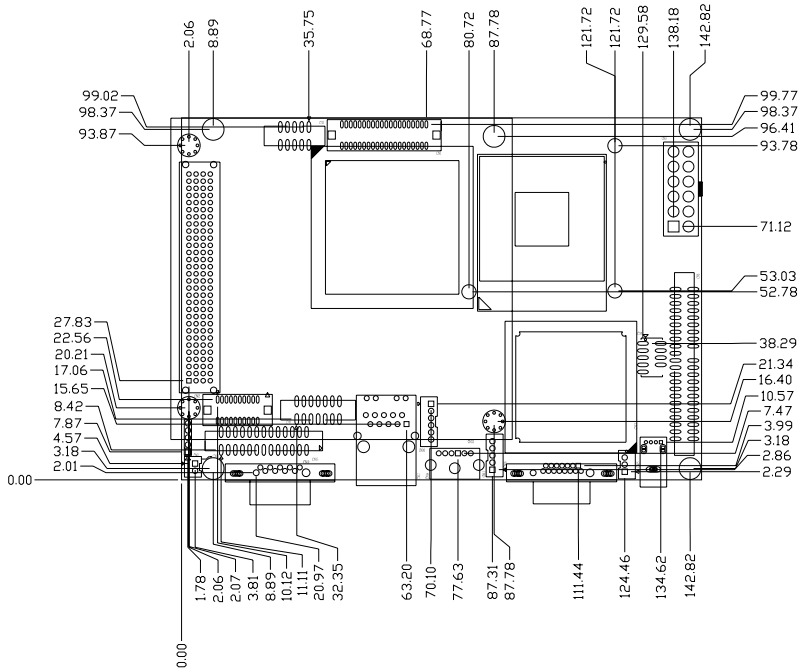

Figure 1.1: Board layout: Dimensions (Component Side)

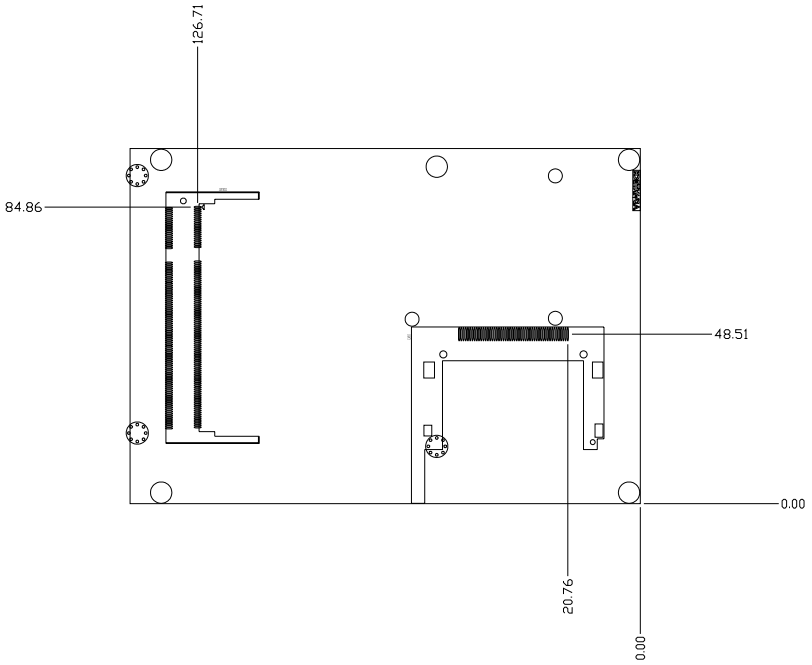

Figure 1.2: Board layout: Dimensions (Solder Side)

Installation

This chapter explains the setup procedures of the PCM-9387 hardware, including instructions on setting jumpers and connecting peripherals, switches and indicators. Be sure to read all safety precautions before you begin the installation procedure.

Chapter 2 Installation

2.1 Jumpers

The PCM-9387 has a number of jumpers that allow you to configure your system to suit your application. The table below lists the functions of the various jumpers.

2.1.1 Jumper Location

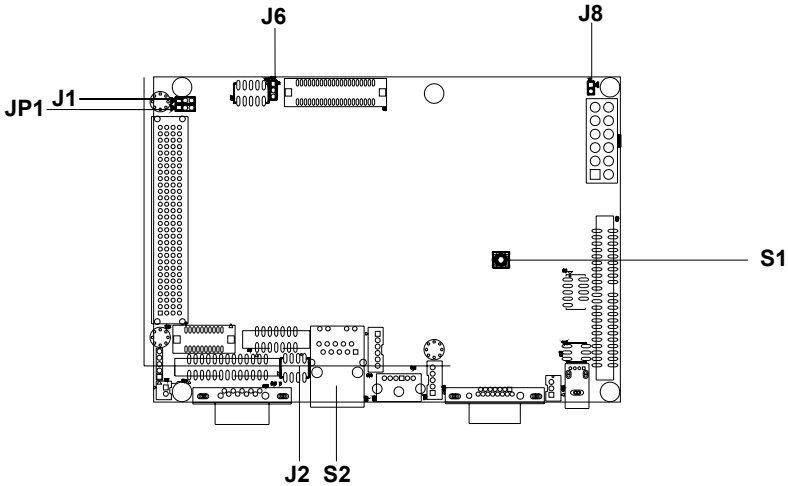

Table 2.1: Jumpers

Label	Function
J1	Audio Power Source
J2	COM2 Auto Flow Setting
J6	LCD POWER
J8	AT/ATX Selector
JP1	PCI VIO
S1	Clear CMOS
S2	Reset Button

2.1.2 Jumper Settings

Table 2.2: Audio Power Selector(J1)

Description	PIN HEADER 3*1P 180D (M) SQUARE 2.0mm
Setting	Function
1-2(*Default)	Audio Power form 12V-input & 5V-output LDO.
2-3	Audio Power from 5V.

Table 2.3: COM2 Setting

Description	PIN HEADER 3*2P 180D SMDMALE SQUARE PIN 2.0mm
Setting	Function
1-2(*Default)	RS232
3-4	RS485
5-6	RS422

Table 2.4: LCD Power Setting (J6)

Description	PIN HEADER 3*1P 180D (M)SQUARE 2.0mm
Setting	Function
1-2	+5V
2-3(*Default)	+3.3V

Table 2.5: AT/ATX Power Setting (J8)

Description	PIN HEADER 2*1P 180D (M)SQUARE 2.0mm
Setting	Function
SHORT	AT POWER(**)
OPEN (*Default)	ATX POWER

** : While use AT power, the standby power connector should be connected to be 5V. Please refer to Appendix D.

Table 2.6: PCI VIO (JPI)

Description	PIN HEADER 2*1P 180D (M) SQUARE 2.0mm
Setting	Function
1-2	5V
2-3	3.3V

Warning! *To avoid damaging the computer, always turn off the power supply before setting “Clear CMOS.” Before turning on the power supply, set the jumper back to “3.0 V Battery On.”*



This jumper is used to erase CMOS data and reset system BIOS information.

The procedure for clearing CMOS is:

1. Turn off the system.
2. Short pin 2 and pin 3.
3. Return jumper to pins 1 and 2.
4. Turn on the system. The BIOS is now reset to its default setting

Table 2.7: CMOS clear

Condition	Result
unpressed (*Default)	Normal
pushed	Clear CMOS

2.2 Connectors

On-board connectors link the PCM-9387 to external devices such as hard disk drives, a keyboard, or floppy drives. The table below lists the function of each of the board's connectors.

Table 2.8: Connectors

Label	Function
CN1	LVDS Connector
CN2	Audio Connector
CN3	ATX Power Connector
CN5	Internal USB connector (Channel 0,1)
CN6	Primary IDE connector
CN7	GPIO connector
CN8	COM2 connector
CN9	External USB connector (Channel2) Connector
CN10	HD LED & Power LED connector
CN11	SMBus connector (optional: SIR)
CN12	LAN Connector
CN13	Print Port connector
CN14	Keyboard /Mouse Connector
CN15	Fan Power connector
CN16	Power Switch connector
CN17	Inverter Power connector
CN18	CRT Connector
CN19	COM1 connector
CN21	CF Connector
CN22	PCI-104 connector
CN23	DVI connector
CN24	extending signals for PCI to ISA bridge

2.3 Locating Connectors

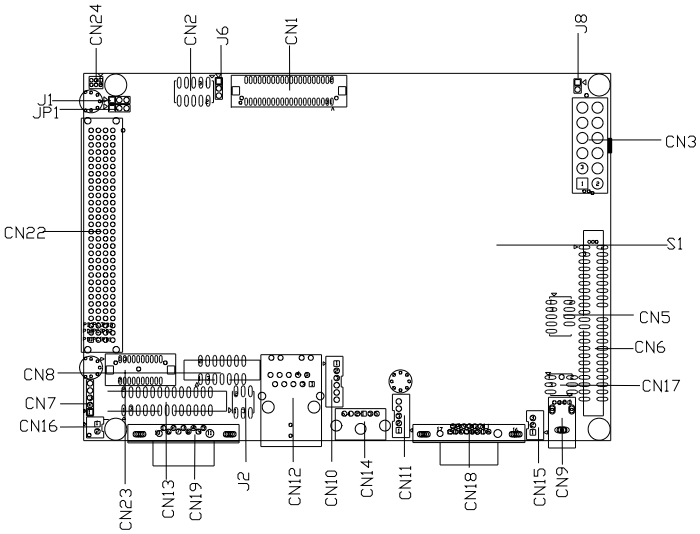

Figure 2.1: Jumpers and Connectors Drawing (component side)

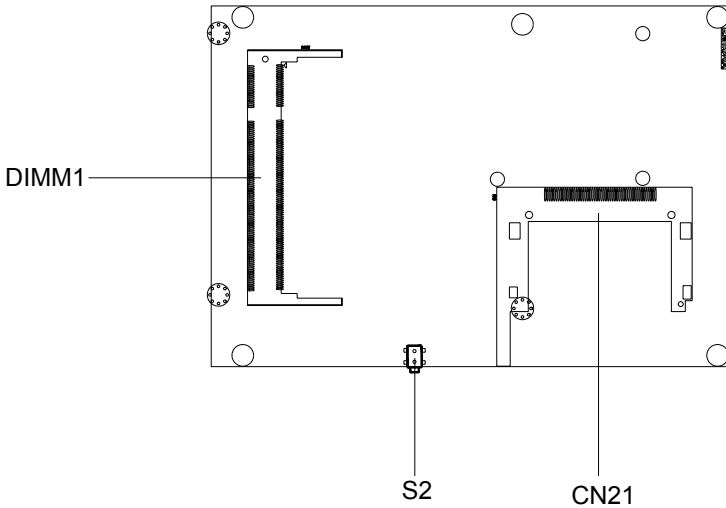
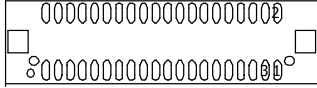
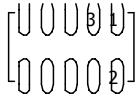
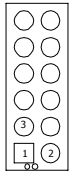

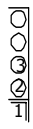
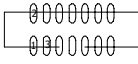
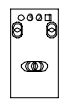
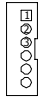
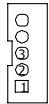
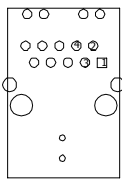

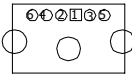



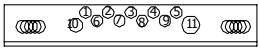
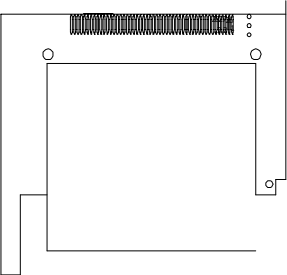

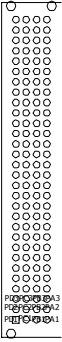
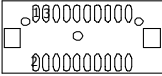
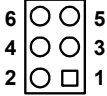



Figure 2.2: Connectors (solder side)



In order to configure each connector easily see Fig.2.1 and Fig 2.2 connector drawings with detailed pin numbers and locations.

Location	Dimension
CN1	
CN2	
CN3	
CN5	
CN6	

CN7	
CN8	
CN9	
CN10	
CN11	
CN12	
CN13	

CN14	
CN15	
CN16	
CN17	
CN18	
CN19	
CN21	

<p>CN22</p>	
<p>CN23</p>	
<p>CN24</p>	
<p>J1</p>	
<p>J2</p>	
<p>J6</p>	

J8	2  1
JP1	

2.4 Setting Jumpers

You may configure your card to match the needs of your application by setting jumpers. A jumper is a metal bridge used to close an electric circuit. It consists of two metal pins and a small metal clip (often protected by a plastic cover) that slides over the pins to connect them. To “close” a jumper, you connect the pins with the clip. To “open” a jumper, you remove the clip. Sometimes a jumper will have three pins, labeled 1, 2 and 3. In this case you would connect either pins 1 and 2, or 2 and 3.

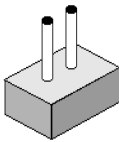

open

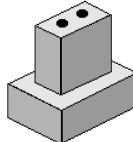

closed

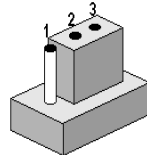

closed 2-3

The jumper settings are schematically depicted in this manual as follows:.

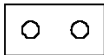

open



closed

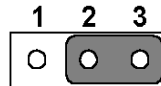

closed 2-3

A pair of needle-nose pliers may be helpful when working with jumpers.

If you have any doubts about the best hardware configuration for your application, contact your local distributor or sales representative before you make any changes.

Generally, you simply need a standard cable to make most connections.

2.5 Installing SO-DIMM

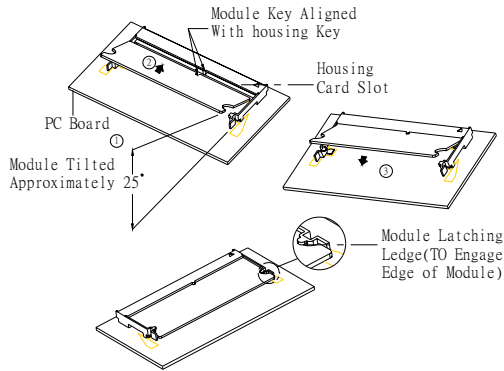

The procedures for installing SODIMMs are described below. Please follow these steps carefully. You can install SDRAM memory modules using 200-pin SODIMMs (Small Outline Dual In-line Memory Modules).

1. Ensure that all power supplies to the system are switched off.
2. Tilt the SODIMM card approximately 25° above the board, and move it in the direction of the housing card slot. Make sure that the key in the module and the key in the housing are aligned.
3. Push the module into the socket until the module bottoms. There should be a slight insertion force to engage the module into the contacts.

2.6 IDE, CDROM hard drive connector (CN6)

The board provides 1 IDE channels which you can attach up to two Enhanced Integrated Device Electronics hard disk drives or CDROM to the board's internal controller. Its IDE controller uses a PCI interface.

This advanced IDE controller supports faster data transfer, PIO mode 3, mode 4 and up to UDMA/33.

2.6.1 Connecting the hard drive

Connecting drives is done in a daisy-chain fashion. This package includes One 44PIN IDE cable that can connect to 1.8" and 2.5" drives.

1. Connect one end of the cable to Hard Drive connector. Make sure that the red (or blue) wire corresponds to pin 1 on the connector, which is labeled on the board (on the right side).
2. Plug the other end of the cable into the Enhanced IDE hard drive, with pin 1 on the cable corresponding to pin 1 on the hard drive. (See your hard drive's documentation for the location of the connector.)

If desired, connect a second drive as described above.

Unlike floppy drives, IDE hard drives can connect to either end of the cable. If you install two drives, you will need to set one as the master and one as the slave by using jumpers on the drives. If you install only one drive, set it as the master.

2.7 Solid State Disk

The board provides a CompactFlash card type I/II socket.

2.7.1 CompactFlash (CN21)

The CompactFlash card shares a secondary IDE channel which can be enabled/disabled via the BIOS settings.

2.8 Parallel port connector (CN13)

Normally, the parallel port is used to connect the card to a printer. The board includes a multi-mode (ECP/EPP/SPP) parallel port accessed via CN13 and a 26-pin flat-cable connector. You will need an adapter cable if you use a traditional DB-25 connector. The adapter cable has a 26-pin connector on one end, and a DB-25 connector on the other.

The parallel port is designated as LPT1, and can be disabled or changed to LPT2 or LPT3 in the system BIOS setup.

The parallel port interrupt channel is designated to be IRQ7.

You can select ECP/EPP DMA channel via BIOS setup.

2.9 Keyboard and PS/2 mouse connector (CN14)

The board provides a keyboard connector that supports both a keyboard and a PS/2 style mouse. In most cases, especially in embedded applications, a keyboard is not used. If the keyboard is not present, the standard PC/AT BIOS will report an error or fail during power-on self-test (POST) after a reset. The PCM-9387's BIOS standard setup menu allows you to select "All, But Keyboard" under the "Halt On" selection. This allows no-keyboard operation in embedded system applications, without the system halting under POST.

2.10 Power & HDD LED Connector (CN10)

Next, you may want to install external switches to monitor and control the board. These features are optional: install them only if you need them. The Power & HDD LED connector is 6-pin Wafer box connector. It provides connections for a power and hard disk access indicator.

2.10.1 Power & HDD LED Connector (CN10)

The HDD LED indicator for hard disk access is an active low signal (24 mA sink rate). Power supply activity LED indicator.

2.10.2 Power Reset button (S2)

Momentarily pressing the reset button will activate a reset. The switch should be rated for 10 mA, 5 V.

2.11 Power connectors (CN3)

2.11.1 Main power connector, +5 V, +12 V (CN3)

Supplies main power to the PCM-9387 (+5 V), and to devices that require +12 V.

2.11.2 Fan power supply connector (CN15)

Provides +5V power supply to CPU cooling fan.

2.12 Audio interfaces (CN2)

2.12.1 Audio connector (CN2)

The board provides all major audio signals on a 10-pin cable connector, These audio signals include Microphone in (mono), Line in (stereo) and Line out (stereo).

2.13 COM port connector (CN8,CN19)

The PCM-9387 provides two serial ports (COM1: RS-232; COM2: RS-232/422/485) in one DB-9 connector (COM1) and one 14-pin dual-inline, male header. It provides connections for serial devices (a mouse, etc.) or a communication network. You can find the pin assignments for the COM port connector in Appendix C.

For COM2, CN19, the default setting is to be used as one internal COM port with RS-232/422/485. The optional function is to be used as two internal RS-232 with different BOM and cable.

2.13.1 COM2 RS-232/422/485 setting (J2)

COM2 can be configured to operate in RS-232, RS-422, or RS-485 mode. This is done via J2

Table 2.9: J2: COM2 Setting

Setting	Function
1-2	RS-232
3-4	RS-485
5-6	RS-422

2.14 VGA/LCD/LVDS interface connections

The board's PCI SVGA interface can drive conventional CRT displays and is capable of driving a wide range of flat panel displays, including passive LCD and active LCD displays. The board has three connectors to support these displays: one for standard CRT VGA monitors, one for flat panel displays, and one for LVDS type LCD panels.

2.14.1 CRT display connector (CN18)

The CRT display connector is a 15-pin D-SUB connector used for conventional CRT displays.

2.14.2 LVDS LCD panel connector (CN1)

The board supports 2 channel 36-bit (48-bit optional) LVDS LCD panel displays. Users can connect to either an 36-bit or 48-bit LVDS LCD on it.

2.15 Ethernet configuration

The board is equipped with a high performance 32-bit PCI-bus Ethernet interface which is fully compliant with IEEE 802.3U 10/100Mbps and

IEEE 802.3 z/ab 1000BASE-T standards. It is supported by all major network operating systems.

Note: Plugging in the LAN cable, triggers an update of the LAN status LEDs. Unplugging the LAN cable doesn't trigger an update of the LAN status LEDs. After the LAN cable is removed, the LAN status LEDs continue to show the old status

2.15.1 100Base-T/1000Base-T connector (CN12)

100Base-T connections are made via the on-board RJ-45 connector

2.15.2 Network boot (Depends on Ethernet Controller)

The Network Boot feature can be utilized by incorporating the Boot ROM image files for the appropriate network operating system. The Boot ROM BIOS files are included in the system BIOS, which is on the utility CD disc.

2.16 Watchdog timer configuration

An on-board watchdog timer reduces the chance of disruptions which EMP (electro-magnetic pulse) interference can cause. This is an invaluable protective device for standalone or unmanned applications. Setup involves one jumper and running the control software (refer to Appendix A).

2.17 USB connectors (CN5,CN9)

The board provides up to three USB (Universal Serial Bus) ports. This gives complete Plug and Play, and hot attach/detach for up to 127 external devices. The USB interfaces comply with USB specification Rev. 2.0 which supports 480Mbps transfer rate, and are fuse protected.

The USB interface is accessed through one 5 x 2-pin flat-cable connectors, CN5 (USB0, 1). You will need an adapter cable if you use a standard USB connector. The adapter cable has a 5 x 2-pin connector on one end and a USB connector on the other.

Also, There's one USB2.0 jack on CN9 for convenient connecting USB device.

The USB interfaces can be disable in the system BIOS setup.

2.18 GPIO (General Purpose Input Output) (CN7)

The board supports 5-bit GPIO through GPIO connector. The 4 digital in- and out-puts can be programmed to read or control devices, with input or out- put defined. The default setting is 2 bits input and 2 bits output.

2.19 SMBus connector (default); SIR (optional) (CN11)

2.19.1 SMBus

The board can support SMBus as default value through CN11 connector. SMBus is the System Management Bus and usually used it for low-speed system management communications. This Board supports SMBus for Advantech embedded API - SUSI (Secured and Unified Smart Interface). It allows a developer to interface a Windows XP or CE PC to a down-stream embedded system environment and transfer serial messages using the SMBus protocols. You will be able to control multiple device simultaneously.

2.19.2 SIR

The board provides an IrDA port for transfer rates of 115 kbps. This connector supports the optional wireless infrared transmitting and receiving module, which is mounted on the system case. Configuration of the module is done through BIOS setup

2.20 Extending signals for PCI-ISA bridge (CN24)

This connector is reserved for adding on those PC/104 modules which is used IT888G chipset, such as PCM-3117.

CHAPTER
3

**Chipset Software
Installation Utility**

Chapter 3 Chipset Software Installation Utility

3.1 Before you begin

To facilitate the installation of the enhanced display device drivers and utility software, you should read the instructions in this chapter carefully before you attempt installation. The device drivers for the board are located on the software installation CD. The auto-run function of the driver CD will guide and link you to the utilities and device drivers under a Windows system. The Intel[®] Chipset Software Installation Utility is not required on any systems running Windows NT 4.0. Updates are provided via Service Packs from Microsoft*.

Note: The files on the software installation CD are compressed. Do not attempt to install the drivers by copying the files manually. You must use the supplied SETUP program to install the drivers.

Before you begin, it is important to note that most display drivers need to have the relevant software application already installed in the system prior to installing the enhanced display drivers. In addition, many of the installation procedures assume that you are familiar with both the relevant software applications and operating system commands. Review the relevant operating system commands and the pertinent sections of your application software's user manual before performing the installation.

3.2 Introduction

The Intel[®] Chipset Software Installation (CSI) utility installs to the target system the Windows INF files that outline to the operating system how the chipset components will be configured. This is needed for the proper functioning of the following features:

- Core PCI and ISA PnP services.
- USB 1.1 support (USB 2.0 driver needs to be installed separately)
- Identification of Intel[®] chipset components in the Device Manager.

- Integrates superior video features. These include filtered sealing of 720 pixel DVD content, and MPEG-2 motion compensation for software DVD

Note: This utility is used for the following versions of Windows system, and it has to be installed before installing all the other drivers:

Windows 98SE

Windows 2000

Windows XP

3.3 Installing the CSI Utility

1. Insert the driver CD into your system's CD-ROM drive. In a few seconds, the cd main menu appears. Move to "\\PCM-9387\1_FIRST_INST". And click "INFINST_ENU" icon.

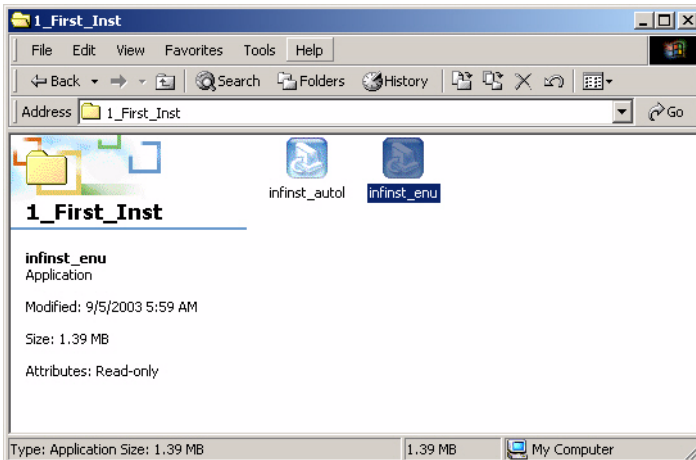

2. Click "Next" when you see the following message.



3. Click "Yes" when you see the following message.



- Click "Next" when you see the following message.

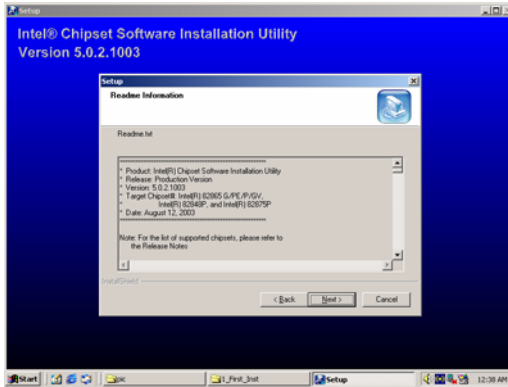

- When the following message appears, click "Finish" to complete the installation and restart Windows.

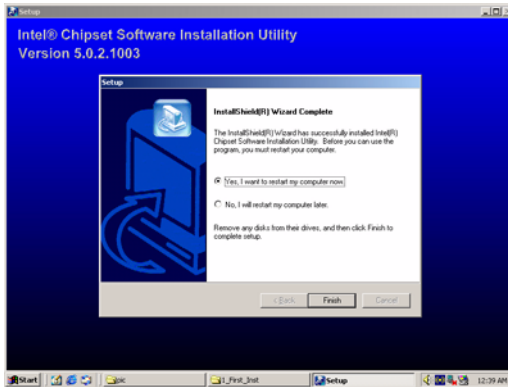

CHAPTER **4**

Award BIOS Setup

Chapter 4 Award BIOS Setup

4.1 Introduction

Award's BIOS ROM has a built-in setup program that allows users to modify the basic system configuration. This type of information is stored in battery-backed memory (CMOS RAM) so that it retains the setup information when the power is turned off.

4.1.1 CMOS RAM Auto-backup and Restore

The CMOS RAM is powered by an onboard button cell battery. When you finish BIOS setup, the data in CMOS RAM will be automatically backed up to Flash ROM. If operation in harsh industrial environment cause a soft error, BIOS will recheck the data in CMOS RAM and automatically restore the original data in Flash ROM to CMOS RAM for booting.

Note: If you intend to change the CMOS setting without restoring the previous backup, you have to click on "DEL" within two seconds of the "CMOS checksum error..." display screen message appearing. Then enter the "Setup" screen to modify the data. If the "CMOS checksum error..." message appears again and again, please check to see if you need to replace the battery in your system.

4.2 Entering Setup

Turn on the computer and check for the “patch code”. If there is a number assigned to the patch code, it means that the BIOS supports your CPU.

If there is no number assigned to the patch code, please contact Advantech’s applications engineer to obtain an up-to-date patch code file. This will ensure that your CPU’s system status is valid. After ensuring that you have a number assigned to the patch code, press to allow you to enter the setup.

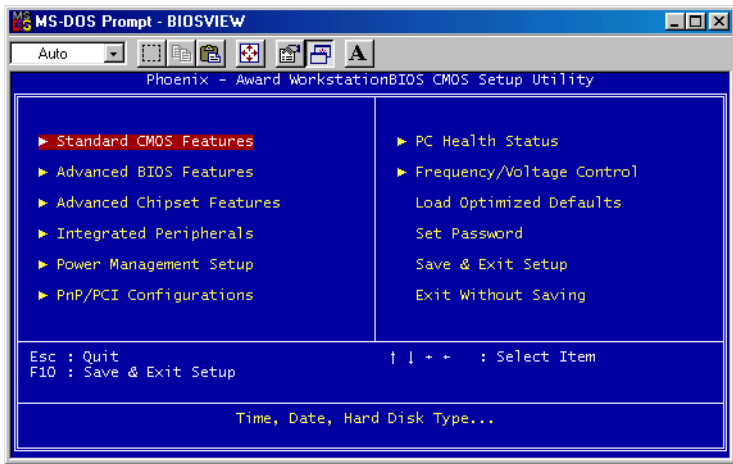

Figure 4.1: Award BIOS Setup initial screen

4.3 Standard CMOS Setup

Choose the “Standard CMOS Features” option from the “Initial Setup Screen” menu, and the screen below will be displayed. This menu allows users to configure system components such as date, time, hard disk drive, floppy drive, display, and memory.

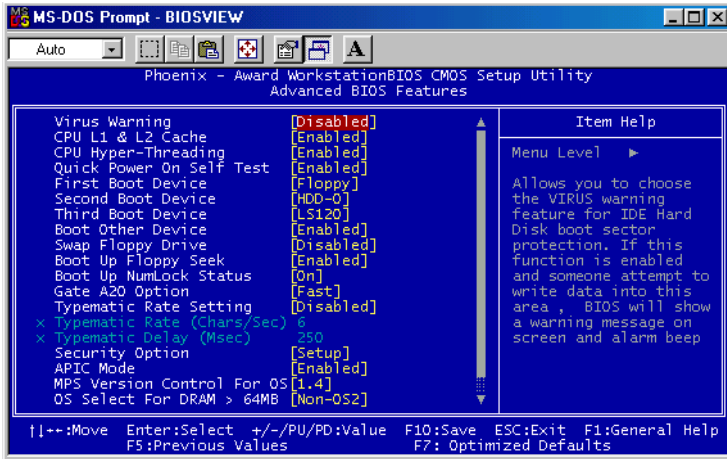

Figure 4.2: Standard CMOS features screen

4.4 Advanced BIOS Features

The “Advanced BIOS Features” screen appears when choosing the “Advanced BIOS Features” item from the “Initial Setup Screen” menu. It allows the user to configure the PCM-9387 according to his particular requirements. Below are some major items that are provided in the Advanced BIOS Features screen. A quick booting function is provided for your convenience. Simply enable the Quick Booting item to save yourself valuable time.

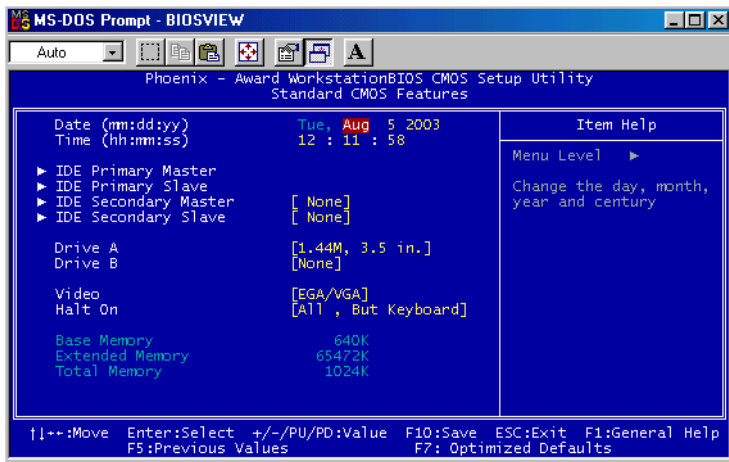

Figure 4.3: Advanced BIOS features screen

4.4.1 Virus Warning

If enabled, a warning message and alarm beep activates if someone attempts to write here. The commands are “Enabled” or “Disabled.”

4.4.2 L1 & L2 Cache

Enabling this feature speeds up memory access. The commands are “Enabled” or “Disabled.”

4.4.3 Quick Power On Self Test

This option speeds up the Power-On Self Test (POST) conducted as soon as the computer is turned on. When enabled, BIOS shortens or skips some of the items during the test. When disabled, the computer conducts normal POST procedures.

4.4.4 First/Second/Third/Other Boot Device

The BIOS tries to load the OS with the devices in the sequence selected.

Choices are: Floppy, LS/ZIP, HDD, SCSI, CDROM, LAN, Disabled.

4.4.5 Swap Floppy Drive

Logical name assignments of floppy drives can be swapped if there is more than one floppy drive. The commands are “Enabled” or “Disabled.”

4.4.6 Boot UP Floppy Seek

Selection of the command “Disabled” will speed the boot up. Selection of “Enabled” searches disk drives during boot up.

4.4.7 Boot Up NumLock Status

This feature selects the “power on” state for NumLock. The commands are “Enabled” or “Disabled.”

4.4.8 Gate A20 Option

Normal: A pin in keyboard controller controls GateA20

Fast (Default): Chipset controls GateA20.

4.4.9 Typematic Rate Setting

The typematic rate is the rate key strokes repeat as determined by the keyboard controller. The commands are “Enabled” or “Disabled.” Enabling allows the typematic rate and delay to be selected.

4.4.10 Typematic Rate (Chars/Sec)

BIOS accepts the following input values (characters/second) for typematic rate: 6, 8, 10, 12, 15, 20, 24, 30.

4.4.11 Typematic Delay (msec)

Typematic delay is the time interval between the appearance of two consecutive characters, when holding down a key. The input values for this category are: 250, 500, 750, 1000 (msec).

4.4.12 Security Option

This setting determines whether the system will boot up if the password is denied. Access to Setup is always limited.

System The system will not boot, and access to Setup will be denied if the correct password is not entered at the prompt.

Setup The system will boot, but access to Setup will be denied if the correct password is not entered at the prompt.

Note: To disable security, select "PASSWORD SETTING" in the main menu. At this point, you will be asked to enter a password. Simply press <Enter> to disable security. When security is disabled, the system will boot, and you can enter Setup freely.

4.4.13 APIC Mode

This setting allows selecting an OS with greater than 64MB of RAM. Commands are "Non-OS2" or "OS2."

4.4.14 MPS Version Control For OS

This reports if an FDD is available for Windows 95. The commands are "Yes" or "No."

4.5 Integrated Peripherals

4.5.1 IDE Master/Slave PIO/UDMA Mode,

IDE Primary (Secondary) Master/Slave PIO/UDMA Mode (Auto) Each channel (Primary and Secondary) has both a master and a slave, making four IDE devices possible. Because each IDE device may have a different Mode timing (0, 1, 2, 3, 4), it is necessary for these to be independent. The default setting "Auto" will allow auto detection to ensure optimal performance.

4.5.2 On-Chip Secondary PCI IDE

If you enable IDE HDD Block Mode, the enhanced IDE driver will be enabled. Leave IDE HDD Block Mode on the default setting.

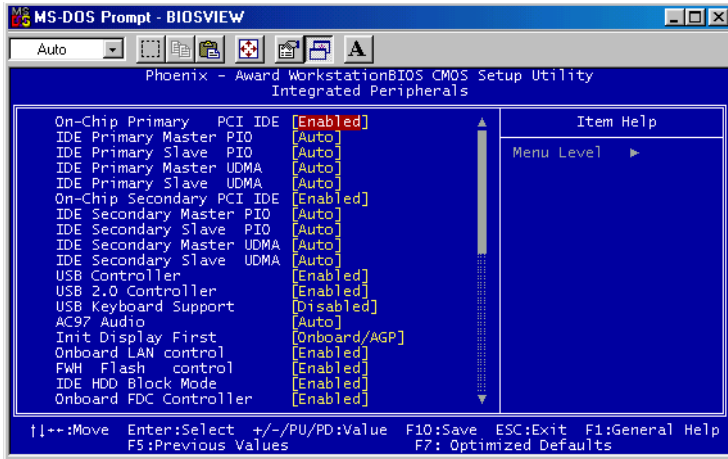

Figure 4.4: Integrated peripherals

4.5.3 USB Controller

Select Enabled if your system contains a Universal Serial Bus (USB) controller and you have USB peripherals. The choices: Enabled, Disabled.

4.5.4 USB Keyboard/Mouse Support

Select Enabled if user plan to use an USB keyboard. The choice: Enabled, Disable.

4.5.5 AC97 Audio

Select Disable if you do not want to use AC-97 audio. Option is Auto, Disable.

4.5.6 Init Display First

This item allows you to choose which one to activate first, PCI Slot or on-chip VGA. The choices: PCI Slot, Onboard.

4.5.7 Onboard LAN Controller

Option is Enable and Disable. Select Disable if user does not want to use onboard LAN controller1.

4.5.8 IDE HDD Block Mode

You can enable the Primary IDE channel and/or the Secondary IDE channel. Any channel not enabled is disabled. This field is for systems with only SCSI drives.

4.5.9 Onboard FDC Controller

When enabled, this field allows you to connect your floppy disk drives to the onboard floppy disk drive connector instead of a separate controller card. If you want to use a different controller card to connect the floppy disk drives, set this field to Disabled.

4.5.10 Onboard Serial Port

For settings reference the Appendix for the serial resource allocation, and Disabled for the on-board serial connector

4.5.11 UART Mode Select

This item allows you to select UART mode. The choices: IrDA, ASKIR, Normal.

4.5.12 RxD, TxD Active

This item allows you to determine the active of RxD, TxD. The Choices: “Hi, Hi,” “Lo, Lo,” “Lo, Hi,” “Hi, Lo.”

4.5.13 IR Transmission Delay

This item allows you to enable/disable IR transmission delay. The choices: Enabled, Disabled.

4.5.14 UR2 Duplex Mode

This item allows you to select the IR half/full duplex function. The choices: Half, Full.

4.5.15 Onboard Parallel Port

This field sets the address of the on-board parallel port connector. You can select either 3BCH/IRQ7, 378H/IRQ7, 278H/IRQ5 or Disabled. If you install an I/O card with a parallel port, make sure there is no conflict in the address assignments. The CPU card can support up to three parallel ports, as long as there are no conflicts for each port.

4.5.16 Parallel Port Mode

This field allows you to set the operation mode of the parallel port. The setting “Normal” allows normal speed operation, but in one direction only. “EPP” allows bidirectional parallel port operation at maximum speed. “ECP” allows the parallel port to operate in bi-directional mode and at a speed faster than the maximum data transfer rate. “ECP + EPP” allows normal speed operation in a two-way mode.

4.5.17 EPP Mode Select

This field allows you to select EPP port type 1.7 or 1.9. The choices: EPP1.7, 1.9.

4.5.18 ECP Mode Use DMA

This selection is available only if you select “ECP” or “ECP + EPP” in the Parallel Port Mode field. In ECP Mode Use DMA, you can select DMA channel 1, DMA channel 3, or Disable. Leave this field on the default setting.

4.6 Power Management Setup

The power management setup controls the CPU card’s “green” features to save power. The following screen shows the manufacturer’s defaults:

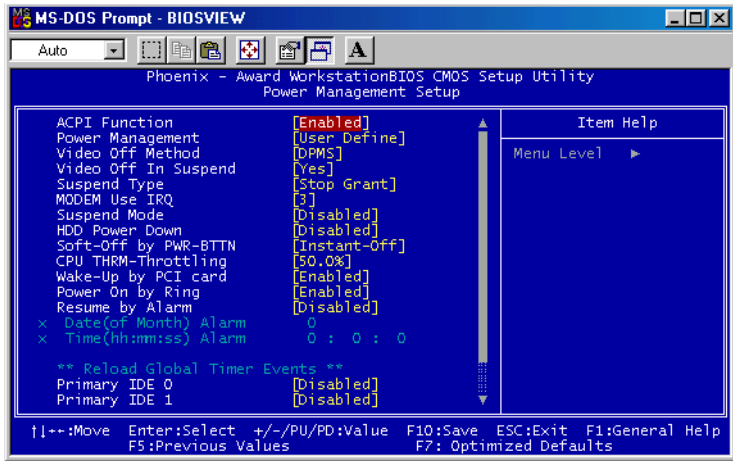

Figure 4.5: Power management setup screen

4.6.1 Power-Supply Type

Choose AT or ATX power supply

4.6.2 ACPI function

The choice: Enabled, Disabled.

4.6.3 Power Management

This category allows you to select the type (or degree) of power saving and is directly related to the following modes:

1. HDD Power Down
2. Suspend Mode

There are four selections for Power Management, three of which have fixed mode settings.

Min. Power Saving	Minimum power management., Suspend Mode = 1 hr., and HDD Power Down = 15 min.
Max. Power Saving	Maximum power management., Suspend Mode = 1 min., and HDD Power Down = 1 min.
User Defined (Default)	Allows you to set each mode individually. When not disabled, each of the ranges are from 1 min. to 1 hr. except for HDD Power Down which ranges from 1 min. to 15 min. and disable.

4.6.4 Video Off In Suspend

When system is in suspend, video will turn off.

4.6.5 Modem Use IRQ

This determines the IRQ in which the MODEM can use. The choices: 3, 4, 5, 7, 9, 10, 11, NA.

4.6.6 HDD Power Down

You can choose to turn the HDD off after one of the time intervals listed, or when the system is in “suspend” mode. If the HDD is in a power saving mode, any access to it will wake it up.

4.6.7 Soft-Off by PWR-BTTN

If you choose “Instant-Off”, then pushing the ATX soft power switch button once will switch the system to “system off” power mode. You can choose “Delay 4 sec.” If you do, then pushing the button for more than 4 seconds will turn off the system, whereas pushing the button momentarily (for less than 4 seconds) will switch the system to “suspend” mode.

4.6.8 CPU THRM-Throttling

This field allows you to select the CPU THRM-Throttling rate. The choices: 12.5%, 25.0%, 37.5%, 50.0%, 62.5%, 75.0%, 87.5%.

4.6.9 PowerOn By LAN

This item allows you to wake up the system via LAN from the remote-host. The choices: Enabled, Disabled.

4.6.10 PowerOn By Modem

When Enabled, an input signal on the serial Ring Indicator (RI) line (in other words, an incoming call on the modem) awakens the system from a soft off state. The choices: Enabled, Disabled.

4.6.11 PowerOn By Alarm

When Enabled, you can set the date and time at which the RTC (real-time clock) alarm awakens the system from Suspend mode. The choices: Enabled, Disabled.

4.6.12 Primary IDE 0 (1) and Secondary IDE 0 (1)

When Enabled, the system will resume from suspend mode if Primary IDE 0 (1) or Secondary IDE 0 (1) is active. The choice: Enabled, Disabled.

4.6.13 FDD, COM, LPT PORT

When Enabled, the system will resume from suspend mode if FDD, COM port, or LPT port is active. The choice: Enabled, Disabled.

4.6.14 PCI PIRQ [A-D]#

When Enabled, the system will resume from suspend mode if interrupt occurs. The choice: Enabled, Disabled.

4.7 PnP/PCI Configurations

4.7.1 PnP OS Installed

Select Yes if you are using a plug and play capable operating system.
Select No if you need the BIOS to configure non-boot device

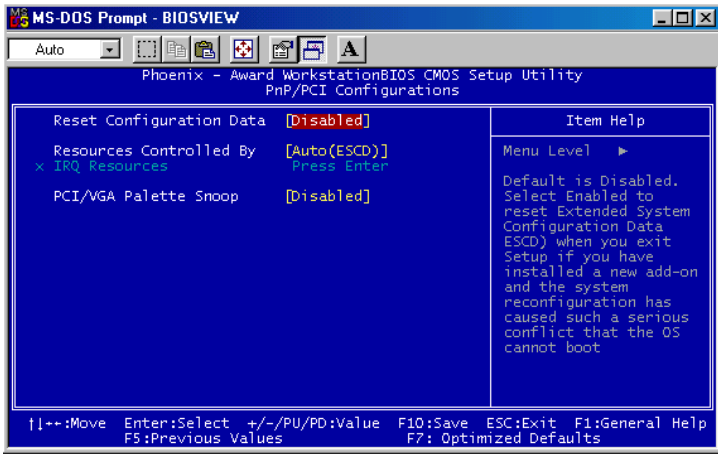

Figure 4.6: PnP/PCI configurations screen

4.7.2 Reset Configuration Data

Default is Disable. Select Enable to reset Extended System Configuration Data (ESCD) if you have installed a new add-on and system configuration has caused such a conflict that OS cannot boot.

4.7.3 Resources controlled by:

The commands here are “Auto” or “Manual.” Choosing “manual” requires you to choose resources from each following sub-menu. “Auto” automatically configures all of the boot and Plug and Play devices but you must be using Windows 95 or above.

4.7.4 PCI/VGA Palette Snoop

This is left at “Disabled.”

4.8 Password Setting

To change the password:

1. Choose the “Set Password” option from the “Initial Setup Screen” menu and press <Enter>.

The screen will display the following message:

Please Enter Your Password

Press <Enter>.

2. If the CMOS is good or if this option has been used to change the default password, the user is asked for the password stored in the CMOS. The screen will display the following message:

Please Confirm Your Password

Enter the current password and press <Enter>.

3. After pressing <Enter> (ROM password) or the current password (user-defined), you can change the password stored in the CMOS. The password must be no longer than eight (8) characters.

Remember, to enable the password setting feature, you must first select either “Setup” or “System” from the “Advanced BIOS Features” menu.

4.9 Save & Exit Setup

If you select this and press <Enter>, the values entered in the setup utilities will be recorded in the CMOS memory of the chipset. The microprocessor will check this every time you turn your system on and compare this to what it finds as it checks the system. This record is required for the system to operate.

4.10 Exit Without Saving

Selecting this option and pressing <Enter> lets you exit the setup program without recording any new values or changing old ones.

PCI SVGA/LCD Setup

This chapter details the software configuration information. It shows you how to configure the card to match your application requirements. The AWARD System BIOS is covered in Chapter 4.

Sections include:

- Installation of SVGA drivers
 - for Windows 98
 - for Windows NT/2000/XP
- Connections for standard LCDs
- Further information

Chapter 5 PCI SVGA/LCD Setup

5.1 Introduction

The board has an onboard Intel 852GM chipset for its AGP/SVGA controller. It supports LVDS LCD displays and conventional analog CRT monitors with 64MB frame buffer shared with system memory. The VGA controller can drive CRT displays with resolutions up to 1600 x 1200@85-Hz and support 2 channel LVDS display mode up to UXGA panel resolution with frequency range from 25-MHz to 112-MHz

5.1.1 CMOS setting for panel type

The PCM-9387 system BIOS and custom drivers are located in a 512 Kbyte, Flash ROM device, designated U29. A single Flash chip holds the system BIOS, VGA BIOS and network Boot ROM image. The display can be configured via CMOS settings. This method minimized the number of chips and different type of LCD panels, please choose "panel type" from the "integrated peripherals" menu in CMOS setting.

5.1.2 Display type

The PCM-9387F can be set in one of three configurations: on a CRT, on a flat panel display, or on both dual independent display. The system is initially set to dual display mode. If you want to enable the CRT display only or the flat panel display only, please contact Intel Corporation or our sales representative for detailed information.

5.1.3 Dual Independent Display

The PCM-9387F uses a Intel 852GM controller that is capable of providing multiple views and simultaneous display with mixed video and graphics on a flat panel and CRT.

To set up dual display under Windows 98, Windows NT/2000/XP follow these steps:

1. Select "Windows98", "Control panel", "Setting", "Advanced", "Graphics Properties" "Device".

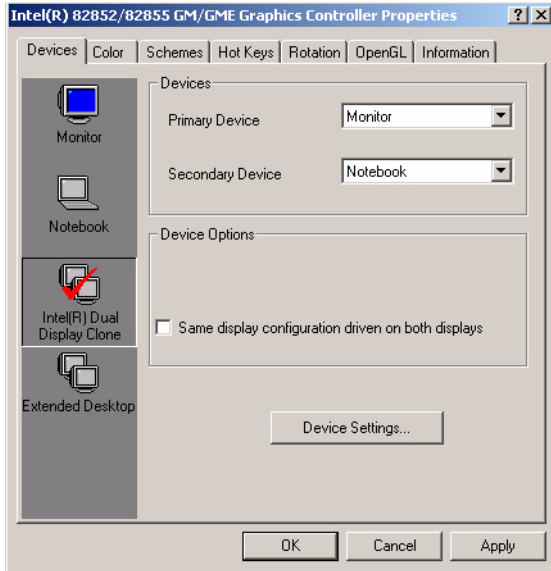

2. Select “1” for current display, or “2” for second display.

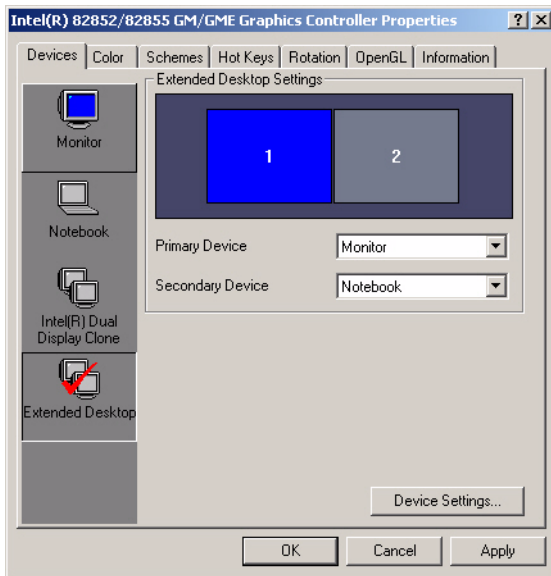

3. Enable “Extend my Windows desktop onto this monitor”.

4. Click “OK”.

5.2 Connections to Two Standard LCDs

The following tables illustrate typical LCD connection pinouts for the PCM-9387.

5.2.1 LG LM 150x06 (1024x768 LVDS LCD)

Table 5.1: Connections to LCD/Flat Panel (CN1)

LCD Connector		Flat Panel Connector	
Unipac-UB104S01		DF-13 40P	
Pin	Function	Pin	Function
1	VCC	1	+5V
2	VCC	2	+5V
3	GND	3	GND
4	GND	4	GND
5	RxIN0-	7	LVDS_YAM0R
6	RxIN0+	9	LVDS_YAP0R
7	GND	11	GND
8	RxIN1-	13	LVDS_YAM1R
9	RxIN1+	15	LVDS_YAP1R
10	GND	17	GND
11	RxIN2-	19	LVDS_YAM2R
12	RxIN2+	21	LVDS_YAP2R
13	GND	23	GND
14	CKIN-	25	LVDS_CLKAMR
15	CKIN+	27	LVDS_CLKAPR
16	GND	29	GND
17	NC		NC
18	NC		NC
19	GND	33	GND
20	GND	34	GND

* LCD connector type: HRS DF 19K-20P-1H or compatible

5.2.2 AU M170EG01 (1280x1024 TFT LCD @ 48bit)

Table 5.2: Connections to AU M170EG01 (CN1)

AU M170EG01		PCM-9387 CN1	
Pin	Function	Pin	Function
1	RxOIN0-	7	LVDS_YAM0
2	RxOIN0+	9	LVDS_YAP0
3	RxOIN1-	13	LVDS_YAM1
4	RxOIN1+	15	LVDS_YAP1
5	RxOIN2-	19	LVDS_YAM2
6	RxOIN2+	21	LVDS_YAP2
7	VSS	11	GND
8	RxOCLKIN-	25	LVDS_CLKAM
9	RxOCLKIN+	27	LVDS_CLKAP
10	RxOIN3-	35	LVDS_YAM3
11	RxOIN3+	37	LVDS_YAP3
12	RxEIN0-	8	LVDS_YBM0
13	RxEIN0+	10	LVDS_YBP0
14	VSS	17	GND
15	RxEIN1-	14	LVDS_YBM1
16	RxEIN1+	16	LVDS_YBP1
17	VSS	23	GND
18	RxEIN2-	20	LVDS_YBM2
19	RxEIN2+	22	LVDS_YBP2
20	RxECLKIN-	26	LVDS_CLKBM
21	RxECLKIN+	28	LVDS_CLKBP
22	RxEIN3-	36	LVDS_YBM3
23	RxEIN3+	38	LVDS_YBP3
24	VSS	29	GND
25	VSS	30	GND
26	NC		NC
27	VSS	33	GND
28	VCC	1	LCD VDD (+5V)
29	VCC	2	LCD VDD (+5V)
30	VCC		

5.3 Installation of the SVGA Driver

Complete the following steps to install the SVGA driver. Follow the procedures in the flow chart that apply to the operating system that you are using within your PCM-9387.

- Notes:**
1. The windows illustrations in this chapter are intended as examples only. Please follow the listed steps, and pay attention to the instructions which appear on your screen.
 2. For convenience, the CD-ROM drive is designated as "D" throughout this chapter.

5.3.1 Installation of Windows 98/2000

1. Find Win98/2000 VGA driver from CD at the directory of PCM-9387 CD, VGA\Win9x_ME\Graphics\Setup

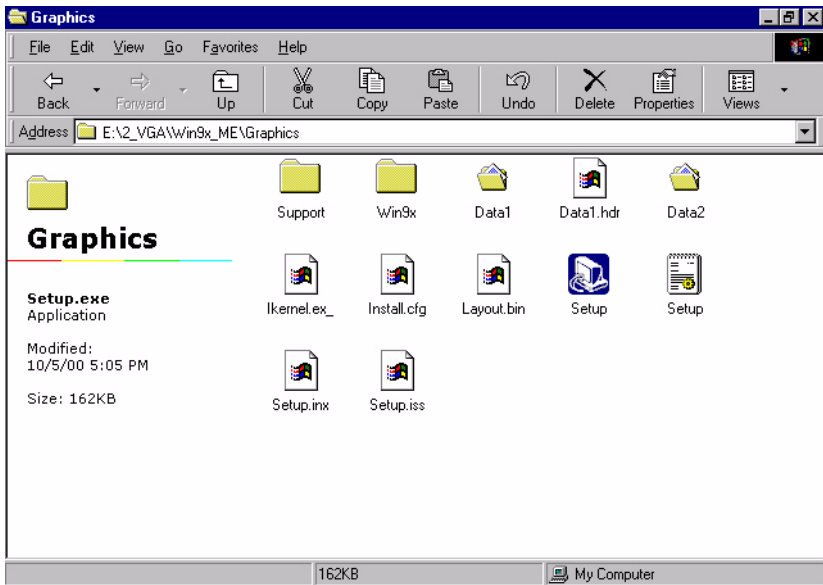

2. Or, find Win2000 VGA driver from CD at the directory of PCM-9387 CD-ROM, VGA\win2k_xp1332.

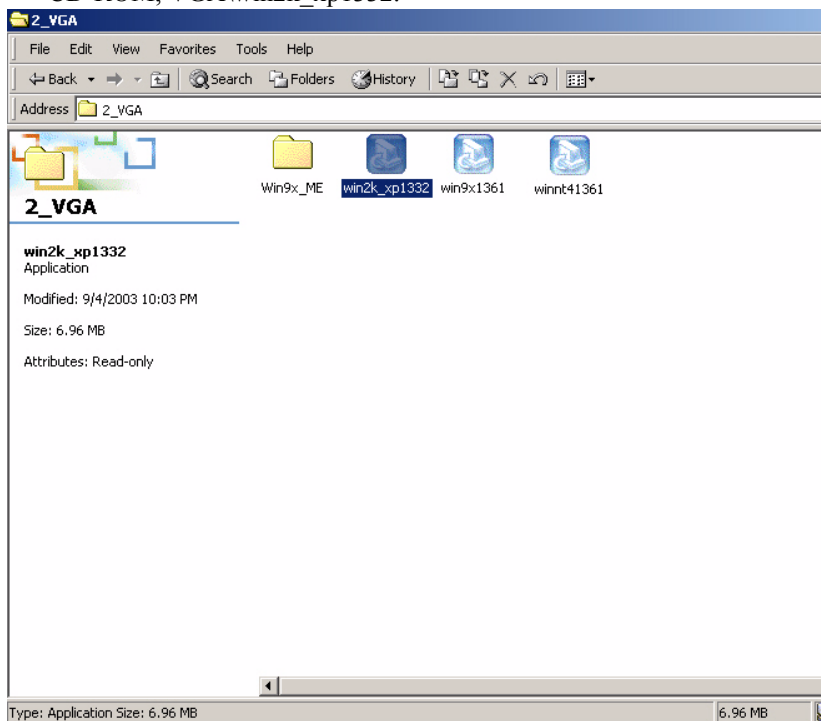

3. Double click "setup" and "next" into setup wizard.

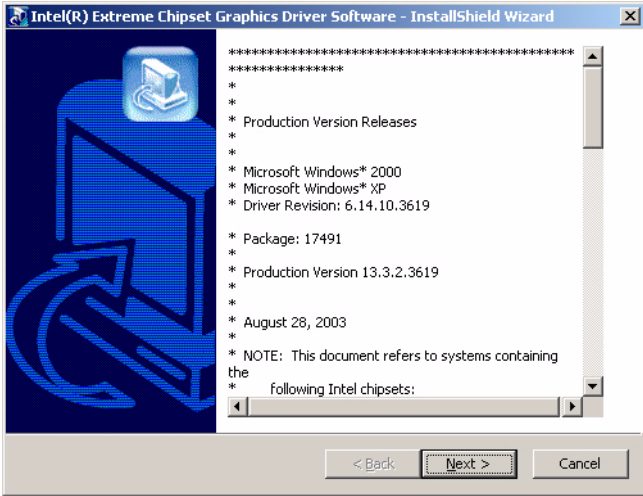

4. Restart computer when installation finished.

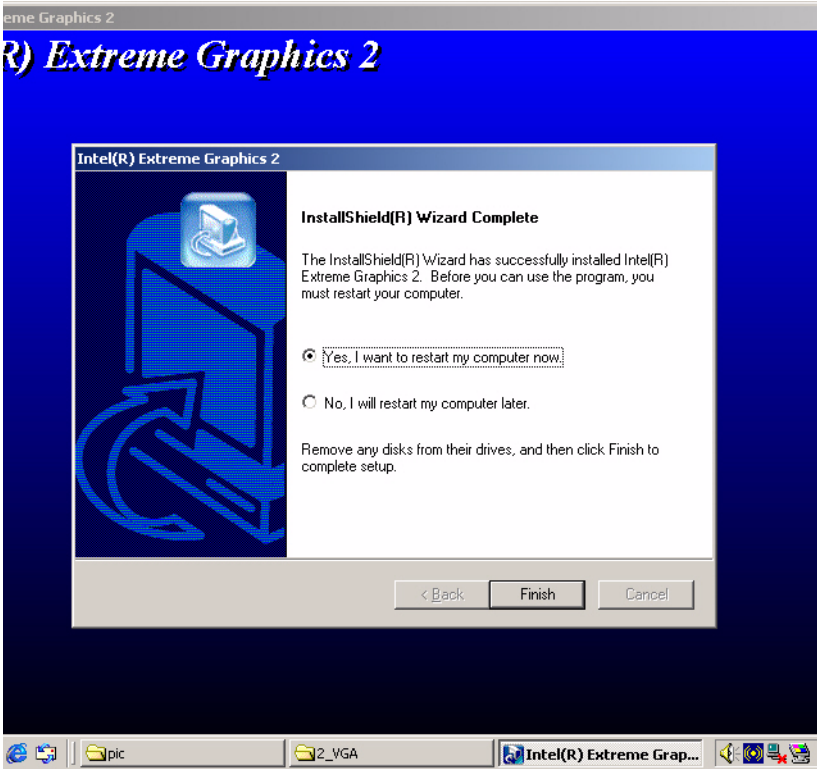

5.4 Further Information

For further information about the AGP/VGA installation in your PCM-9387, including driver updates, troubleshooting guides and FAQ lists, visit the following web resources:

Intel website: www.intel.com

Advantech websites: www.advantech.com

www.advantech.com.tw

Audio Setup

The PCM-9387 is equipped with an audio interface that records and plays back CD-quality audio. This chapter provides instructions for installing the software drivers included on the audio driver diskettes.

Chapter 6 Audio Setup

6.1 Introduction

The PCM-9387's on-board audio interface provides high-quality stereo sound and FM music synthesis (ESFM) by using the Intel ICH4 audio controller. The audio interface can record, compress, and play back voice, sound, and music with built-in mixer control.

6.2 Driver installation

6.2.1 Before you begin

Please read the instructions in this chapter carefully before you attempt installation. The audio drivers for the PCM-9387 board are located on the audio driver CD. Run the supplied SETUP program to install the drivers; don't copy the files manually.

Note: *The files on the software installation diskette are compressed. Do not attempt to install the drivers by copying the files manually. You must use the supplied SETUP program to install the drivers.*

6.2.2 Windows 98 drivers

1. Find Win98/2000 Audio driver folder from CD at the directory of PCM-9387 CD, click "setup" to start the installation process.

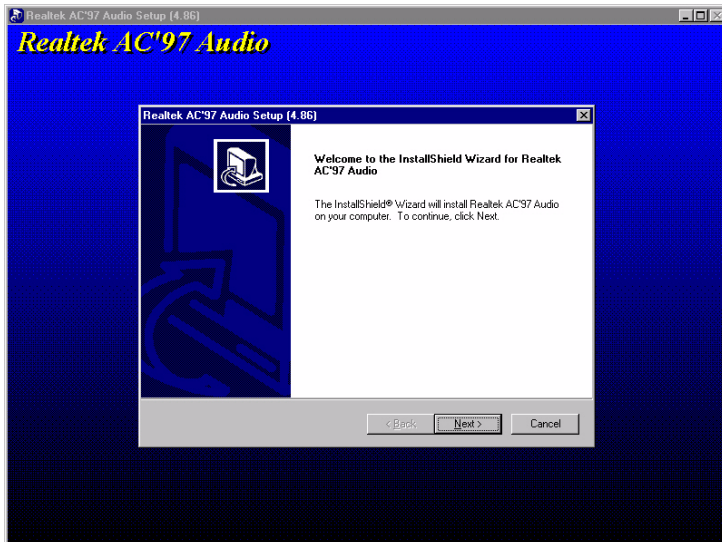
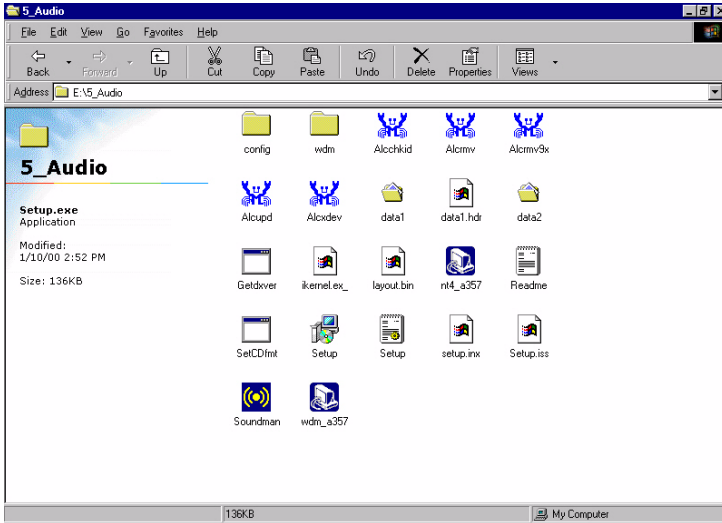

2. Click "yes" to reboot your computer.

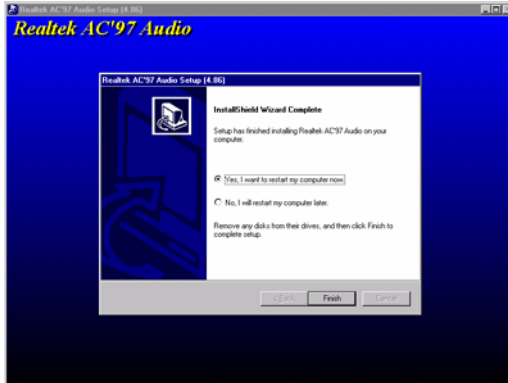

Ethernet Interface

This chapter provides information on Ethernet configuration.

Sections include:

- Introduction
- Installation of Ethernet drivers for Windows 98/2000/NT
- Further information

Chapter 7 Ethernet Interface

7.1 Introduction

The PCM-9387 is equipped with a high performance 32-bit Ethernet chipset which is fully compliant with IEEE 802.3 100 Mbps CSMA/CD standards. It is supported by major network operating systems. It is also both 1000Base-T and 100Base-T compatible. The network boot feature can be utilized by incorporating the boot ROM image files for the appropriate network operating system. The boot ROM BIOS files are combined with system BIOS, which can be enabled/disabled in the BIOS setup.

7.2 Installation of Ethernet driver

Before installing the Ethernet driver, note the procedures below. You must know which operating system you are using in your PCM-9387 Series, and then refer to the corresponding installation flow chart. Then just follow the steps described in the flow chart. You will quickly and successfully complete the installation, even if you are not familiar with instructions for MS-DOS or Windows.

Note: *The windows illustrations in this chapter are examples only. Follow the steps and pay attention to the instructions which appear on your screen.*

7.2.1 Installation for Windows 98

1. a. Select "Start", "Settings", "Control Panel".

b. Double click "Network".



2. a. Click "Add New Hardware" and prepare to install network functions.



3. a. Select the "Adapter" item to add the Ethernet card.

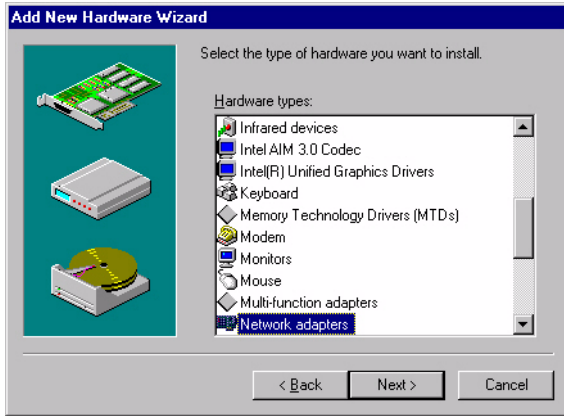

4. a. Click "Have Disk" to install the driver.

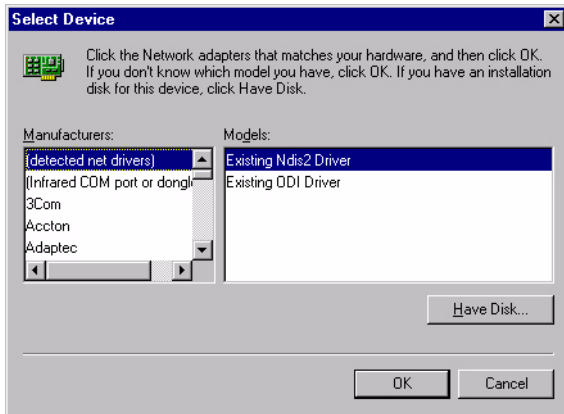

5. a. Insert the CD into the D: drive
b. Fill in "E:\3_LAN\82551ER\W9X&W2K"
c. Click "OK"

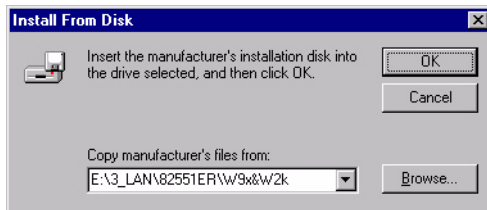

6.
 - a. Choose the "Choose the "Intel(R) GD82559ER PCI Adapter" item.
 - b. Click "Next".

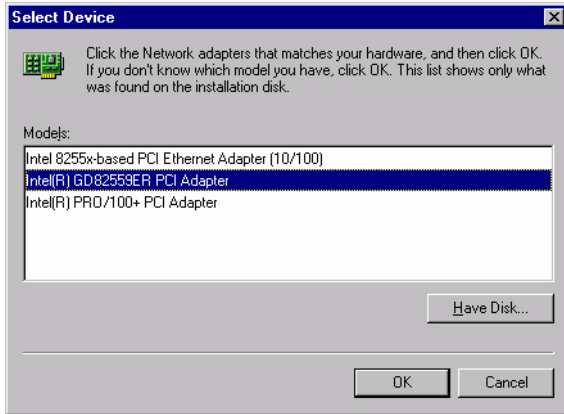

7.
 - a. Make sure the configurations of relative items are set correctly.
 - b. Click "Finish" to reboot.



7.2.2 Installation for Windows 2000

1. a. Select "Start", "Settings", "Control Panel".
b. Double click "Network".

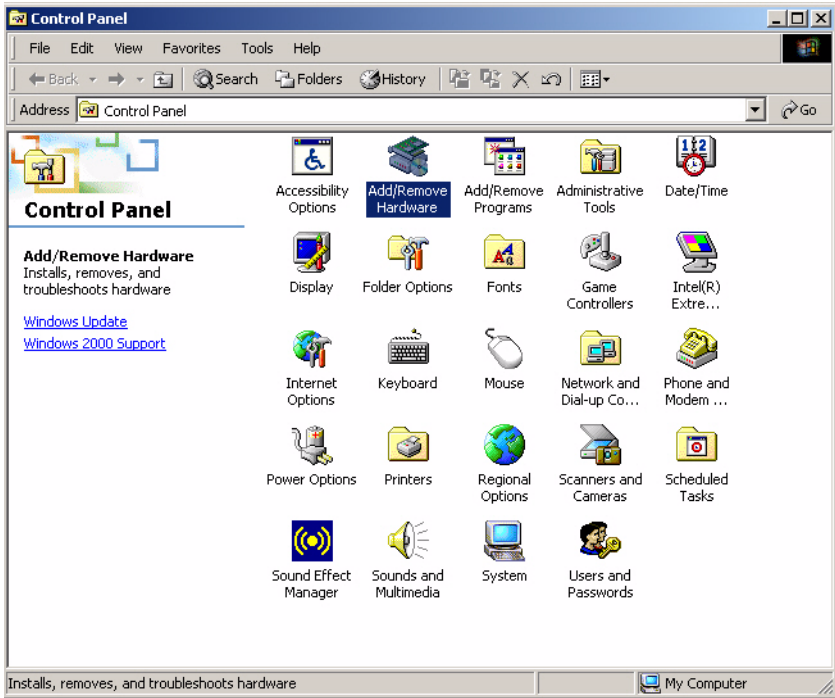

2. Click “Add new hardware wizard” and prepare to install network function

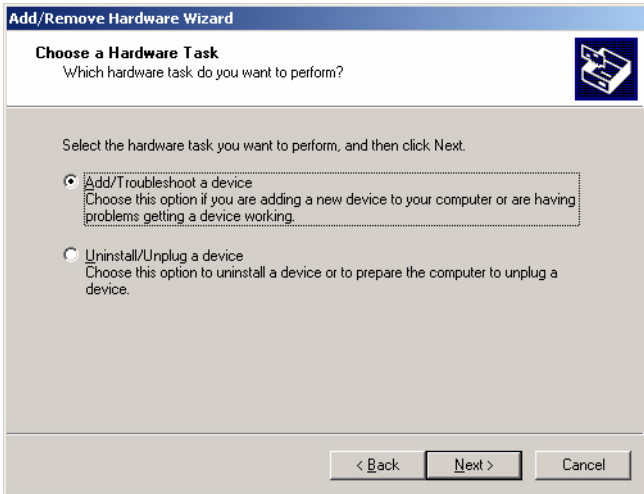

3. Choose Hardware Device “Ethernet Controller”

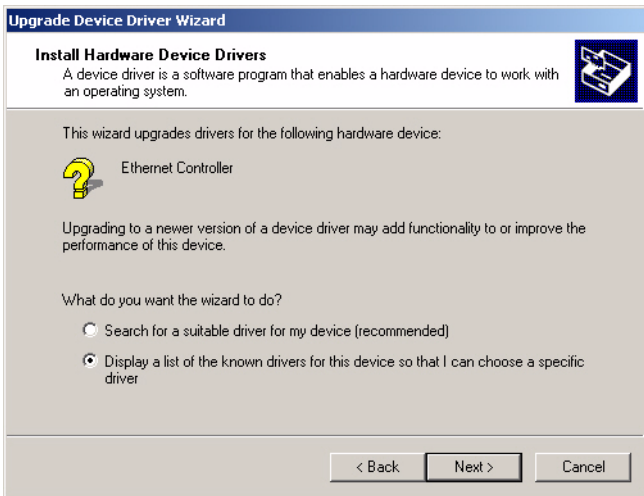

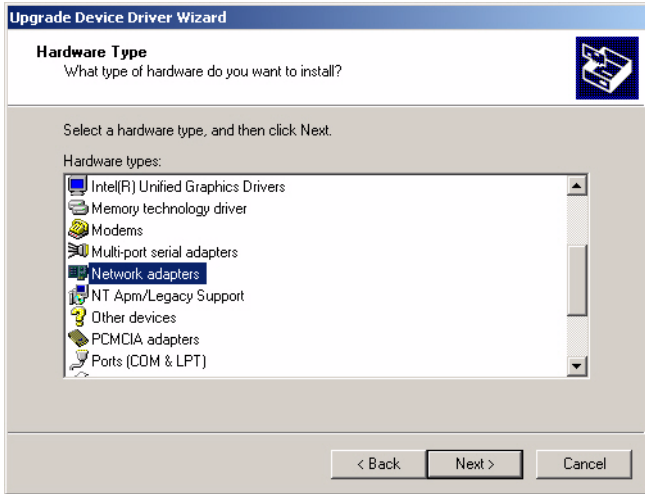

4. Insert the CD into D: drive
 - a. Fill in the Find the LAN chipset folder at the directory of PCM-9387 win2000 folder from CD ROM drive
 - b. Click "OK".

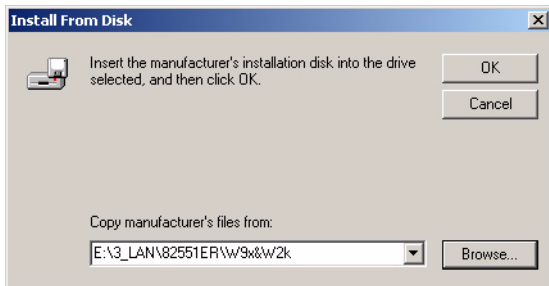

5. Choose the "Intel(R) GD82559ER PCI Adapter" item

Click “Next”

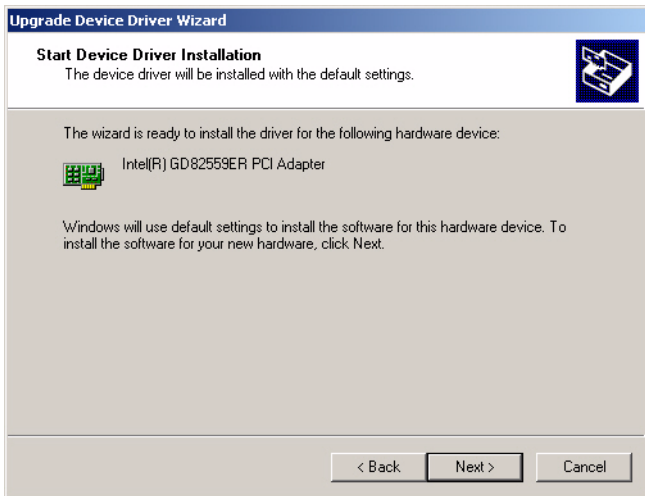
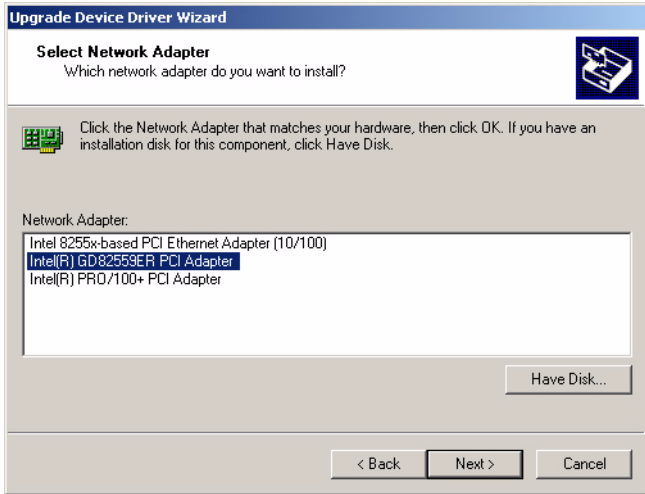

- 6 a. Make sure the configurations of relative items are set correctly

b. Click “OK”



7.3 Further information

Intel website: www.intel.com

Advantech websites: www.advantech.com

www.advantech.com.tw

Programming the GPIO and Watchdog Timer

The PCM-9387 is equipped with a watchdog timer that resets the CPU or generates an interrupt if processing comes to a standstill for any reason. This feature ensures system reliability in industrial standalone or unmanned environments.

Appendix A Programming GPIO & Watchdog Timer

A.1 Supported GPIO Register

Bellow are detailed description of the GPIO addresses and programming sample.

A.1.1 GPIO Registers

CRF0 (GP10-GP17 I/O selection register. Default 0xFF)

When set to a '1', respective GPIO port is programmed as an input port.

When set to a '0', respective GPIO port is programmed as an output port.

CRF1 (GP10-GP17 data register. Default 0x00)

If a port is programmed to be an output port, then its respective bit can be read/written.

If a port is programmed to be an input port, then its respective bit can only be read.

CRF2 (GP10-GP17 inversion register. Default 0x00)

When set to a '1', the incoming/outgoing port value is inverted.

When set to a '0', the incoming/outgoing port value is the same as in data register.

Extended Function Index Registers (EFIRs)

The EFIRs are write-only registers with port address 2Eh or 4Eh on PC/AT systems.

Extended Function Data Registers (EFDRs)

the EFDRs are read/write registers with port address 2Fh or 4Fh on PC/AT systems.

A.1.2 GPIO Example program-1

Enter the extended function mode, interruptible double-write

```
MOV DX,2EH
MOV AL,87H
OUT DX,AL
OUT DX,AL
```

Configure logical device 7(GP10~GP17), configuration register
CRF0,CRF1,CRF2

```
MOV DX,2EH
MOV AL,07H ; point to Logical Device Number Reg.
OUT DX,AL
MOV DX,2FH
MOV AL,07H ; select logical device 7
OUT DX,AL ;
MOV DX,2EH
MOV AL,F0
OUT DX,AL
MOV DX,2FH
MOV AL,00H ; 01:Input 00:output for GP10~GP17
OUT DX,AL
MOV DX,2EH
MOV AL,F2H ;
OUT DX,AL
MOV DX,2FH
MOV AL,00H ;Set GPIO is normal not inverter
OUT DX,AL;
MOV DX,2EH
MOV AL,F1H
```

```
OUT DX,AL
MOV DX,2FH
MOV AL,??H ; Put the output value into AL
OUT DX,AL
```

Exit extended function mode

```
MOV DX,2EH
MOV AL,AAH
OUT DX,AL
```

A.2 Watchdog programming

Bellow is a sample of programming code for controlling the Watchdog Timer function.

Enter the extended function mode,interruptible double-write

```
MOV DX,2EH
MOV AL,87H
OUT DX,AL
OUT DX,AL
```

Configure logical device 8, configuration register CRF6

```
MOV DX,2EH
MOV AL,07H ; point to Logical Device Number Reg.
OUT DX,AL
MOV DX,2FH
MOV AL,08H ; select logical device 8
OUT DX,AL ;
MOV DX,2EH
MOV AL,30H ;Set watch dog activate or inactivate
OUT DX,AL
MOV DX,2FH
MOV AL,01H ; 01:activate 00:inactivate
OUT DX,AL ;
MOV DX,2EH
MOV AL,F5H ; Setting counter unit is second
OUT DX,AL
MOV DX,2FH
MOV AL,00H
OUT DX,AL;
```

```
MOV DX,2EH
MOV AL,F6H
OUT DX,AL
MOV DX,2FH
MOV AL,05H ; Set 5 seconds
OUT DX,AL
;-----
; Exit extended function mode |
;-----
MOV DX,2EH
MOV AL,AAH
OUT DX,AL
```

Pin Assignments

This appendix contains information of a detailed or specialized nature. It includes:

- CPU Fan Power Connector
- Audio Connector
- Main Power Connector
- Keyboard and PS/2 Mouse Connector
- IDE Hard Drive Connector
- Parallel Port Connector
- Power & HDD LED Connector
- USB Connector
- LCD Inverter Power Connector
- LVDS Connector
- COM2 RS-232/422/485 series port
- CompactFlash Card Connector
- IR Connector
- DVI Connector
- GPIO Connector
- SMBus connector
- extending signals for PCI to ISA bridge

Appendix B Pin Assignments

B.1 CPU Fan Power Connector (CN15)

Table B.1: CPU Fan Power connector (CN15)

Description Wafer Box 2.0mm 3P180D w/Lock

Pin	Signal
-----	--------

1	FAN_DET
---	---------

2	VCC
---	-----

3	GND
---	-----

B.2 Audio Connector (CN2)

Table B.2: Audio connector (CN2)

Description BOX HEADER SMD 5*2 180D (M) 2.0mm

Pin	Signal	Pin	Signal
-----	--------	-----	--------

1	LINE OUT R	2	LINE IN R
---	------------	---	-----------

3	GND	4	GND
---	-----	---	-----

5	LINE OUT L	6	LINE IN L
---	------------	---	-----------

7	GND	8	GND
---	-----	---	-----

9	MIC IN	10	Reserved for MIC2
---	--------	----	-------------------

B.3 Main Power Connector (CN3)

Table B.3: Main Power Connector (CN3)

Description		Power CONN. 6*2 180D	
Pin	Signal	Pin	Signal
1	GND	2	GND
3	VCC	4	GND
5	VCC	6	VCCSB
7	GND	8	PWR_PSON#
9	VCC	10	GND
11	VCC	12	+12V

B.4 Keyboard and PS/2 Mouse Connector (CN14)

Table B.4: Keyboard and mouse connector (CN14)

Description		MINI DIN 6P Short body W/Shielding	
Pin	Signal		
1	KB DATA		
2	MS DATA		
3	GND		
4	VCC		
5	KB CLOCK		
6	MS CLOCK		

B.5 IDE Hard Drive Connector (CN6)

Table B.5: IDE HDD connector (CN6)

Description BOX HEADER SMD 22*2P 180 D(M) 2.0mm IDIOT-PROOF			
Pin	Signal	Pin	Signal
1	IDE RESET	2	GND
3	DATA 7	4	DATA 8
5	DATA 6	6	DATA 9
7	DATA 5	8	DATA 10
9	DATA 4	10	DATA 11
11	DATA 3	12	DATA 12
13	DATA 2	14	DATA 13
15	DATA 1	16	DATA 14
17	DATA 0	18	DATA 15
19	GND	20	N/C
21	DRQ	22	GND
23	IO WRITE	24	GND
25	IO READ	26	GND
27	HD READY	28	N/C
29	HDACK 0	30	GND
31	IDE IRQ	32	IOCS16
33	ADDR 1	34	N/C
35	ADDR 0	36	ADDR 2
37	HARD DISK SELECT 0	38	HARD DISK SELECT 1*
39	IDE ACTIVE	40	GND
41	Vcc	42	Vcc
43	GND	44	NC

B.6 Parallel Port Connector (CN13)

Table B.6: Parallel Port Connector (CN13)

Description BOX HEADER SMD 13*2P 180D(M) 2.0mm			
Pin	Signal	Pin	Signal
1	STROBE	2	AUTOFD
3	D0	4	ERR
5	D1	6	INIT
7	D2	8	SLCTINI
9	D3	10	GND
11	D4	12	GND
13	D5	14	GND
15	D6	16	GND
17	D7	18	GND
19	ACK	20	GND
21	BUSY	22	GND
23	PE	24	GND
25	SLCT	26	N/C

B.7 Power & HDD LED Connector (CN10)

Table B.7: Power & HDD LED Connector (CN10)

Description	
Pin	Signal
1	+5V
2	GND
3	power LED+ (+5V)
4	power LED- (GND)
5	HDD LED +
6	HDD LED -

B.8 USB Connector (CN5)

Table B.8: USB connector (CN5)

Description			
Pin	Signal	Pin	Signal
1	VCC	2	VCC
3	USB_P0-	4	USB_P1-
5	USB_P0+	6	USB_P1+
7	GND	8	GND
9	GND	10	NC

B.9 LCD Inverter Power Connector (CN17)

Table B.9: LCD Inverter Power Conn. (CN17)

Part Number	1653003260
Description	PIN HEADER 3*2P 180D SMDMALE SQUARE PIN 2.0mm
Pin	Signal
1	+12 V
2	(ENABKL)
3	(VBR)
4	(+5V)
5	(GND)
6	NC

B.10 LVDS Connector (CN1)

Table B.10: LVDS Connector (CN1)

Description *CONN. DF13-40DP-1.25V			
Pin	Signal	Pin	Signal
1	VDDSAFE5	2	VDDSAFE5
3	GND	4	GND
5	VDDSAFE3	6	VDDSAFE3
7	LVDS_YAM0	8	LVDS_YBM0
9	LVDS_YAP0	10	LVDS_YBP0
11	GND	12	GND
13	LVDS_YAM1	14	LVDS_YBM1
15	LVDS_YAP1	16	LVDS_YBP1
17	GND	18	GND
19	LVDS_YAM2	20	LVDS_YBM2
21	LVDS_YAP2	22	LVDS_YBP2
23	GND	24	GND
25	LVDS_CLKAM	26	LVDS_CLKBM
27	LVDS_CLKAP	28	LVDS_CLKBP
29	GND	30	GND
31	LVDS_DCLK	32	LVDS_DDAT
33	GND	34	GND
35	LVDS_YAM3	36	LVDS_YBM3
37	LVDS_YAP3	38	LVDS_YBP3
39	NC	40	NC

Note: *The model number of the CN1 socket is DF13A-40DP-1.25V (Hirose Electric Co., Ltd.)*

B.11 COM2 RS232/422/485 series port (CN8)

Table B.11: COM2 RS-232/422/485 series port

Description	BOX HEADER SMD 7*2P 180D MALE 2.0mm		
Pin	RS-232 port	RS-422 port	RS-485 port
1	DCD	N/C	N/C
2	DSR	N/C	N/C
3	RXD	N/C	N/C
4	RTS	N/C	N/CN/C
5	TxD	N/C	N/C
6	CTS	N/C	N/C
7	DTR	N/C	N/C
8	RI	N/C	N/C
9	GND	N/C	N/C
10	GND	N/C	N/C
11	N/C	TxD+	DATA+
12	N/C	TxD-	DATA-
13	N/C	RxD+	N/C
14	N/C	RxD-	N/C

B.11.1 CN8, COM2 RS 422/485 - transfer to 2nd internal RS-232

Del R536, R537

Add R538, R539

B.11.2 CN8, 2nd internal RS-232 - transfer to COM2 RS-422/485

Del R538, R539

Add R536, R537

B.12 CompactFlash Card Connector (CN21)

Table B.12: CompactFlash Card Connector (CN21)

Description HEADER for CF type II 50P 90D(M)SMD 3M W/O Ejector			
Pin	Signal	Pin	Signal
1	GND	2	D03
3	D04	4	D05
5	D06	6	D07
7	*CS0	8	A10
9	*ATA SEL	10	A09
11	A08	12	A07
13	+5 V	14	A06
15	A05	16	A04
17	A03	18	A02
19	A01	20	A00
21	D00	22	D01
23	D02	24	-IOCS16
25	*CD2	26	-CD1
27	D11	28	D12
29	D13	30	D14
31	D15	32	-CS1
33	*VS1	34	-IORD
35	*IOWR	36	-WE
37	INTRQ	38	+5 V
39	*CSEL	40	-VS2
41	*RESER	42	IORDY
43	*INPACK	44	-REG
45	*DASP	46	-PDIAG
47	D08	48	D09
49	D10	50	GND

* low active

B.13 SMBus Connector (default); IrDA (optional) (CN11)

Table B.13: SMBUS connector (Default); IrDA connector (Optional) (CN11)

Part Number 1655305020		
Description WAFER BOX 2.0mm 5P 180D MALE W/LOCK		
Pin	Pin name	Pin name
1	+5V	
2	SMBCLK_STBY (Default I)	IR_CIRRX (Optional)
3	SMBDATA_STBY (Default)	IR_IRRX (Optional)
4	GND	
5	IR_IRTX	

B.14 DVI Connector (CN23)

Table B.14: DVI connector (CN23)

Description *CONN. SMD 10*2P 180D(M) DF13-20DP-1.25V HRS			
Pin	Pin Name	Pin	Pin Name
1	TMDS_C0#	2	VCC_DVI
3	TMDS_C0	4	TMDS_CK#
5	GND	6	TMDS_CK
7	TMDS_C1#	8	GND
9	TMDS_C1	10	MDVI_CLK
11	GND	12	MDVI_DATA
13	TMDS_C2#	14	HP_DET
15	TMDS_C2	16	MI2C_DATA
17	VCC_DVI	18	MI2C_CLK
19	NC	20	NC

B.15 GPIO Connector (CN7)

Table B.15: GPIO connector (CN7)

Description PIN HEADER 5*1P 180D(M) SQUARE 2.0mm

Pin	Signal
1	VCC
2	GPIO4
3	GPIO0
4	GPIO5
5	GPIO1

B.16 USB2 Connector(CN9)

Table B.16: USB2 Connector (CN9)

Part Number 1654904105

Description PIN HEADER 5*2P 180(M) 2.0mm SMD IDIOT-PROOF

Pin	Pin Name	Pin	Pin Name
1	VCC	2	D-
3	D+	4	GND
5	GND	6	GND
7	GND		

B.17 Print Port Connector (CN13)

Table B.17: Print Port Connector (CN13)

Description		BOX HEADER SMD 13*2P 180D(M)2.0mm	
Pin	Pin Name	Pin	Net Name
1	STROBE	2	AUTOFD
3	D0	4	ERROR
5	D1	6	INIT
7	D2	8	SLCTINI
9	D3	10	GND
11	D4	12	GND
13	D5	14	GND
15	D6	16	GND
17	D7	18	GND
19	ACK	20	GND
21	BUSY	22	GND
23	PE	24	GND
25	SLCT	26	N/C

B.18 Extending signals for PCI-ISA bridge Connector(CN24)

Table B.18: Extending signals for PCI-ISA bridge Connector (CN24)

Description		PIN Header 3*2P 180D 2.0mm SMD SQUARE PIN WO/Pb	
Pin	Pin Name	Pin	Net Name
1	PCI_ISANOGO#	2	PCI_ISAGNT#
3	PCI_ISAREQ#	4	LPC_SERIRQ

System Assignments

This appendix contains information of a detailed nature. It includes:

- System I/O ports
- 1st MB memory map
- DMA channel assignments
- Interrupt assignments

Appendix C System Assignments

C.1 System I/O Ports

Table C.1: System I/O ports

Addr. range (Hex)	Device
000-01F	DMA controller
020-021	Interrupt controller 1, master
040-05F	8254 timer
060-06F	8042 (keyboard controller)
070-07F	Real-time clock, non-maskable interrupt (NMI) mask
080-09F	DMA page register
0A0-0BF	Interrupt controller 2
0C0-0DF	DMA controller
0F0	Clear math co-processor
0F1	Reset math co-processor
0F8-0FF	Math co-processor
1F0-1F8	Fixed disk
200-207	Reserved (Game I/O)
278-27F	Reserved (Parallel port 2,LTP3)
2E8-2EF	Reserved (Series port 4)
2F8-2FF	Serial port 2
300-31F	Prototype card
360-36F	Reserved
378-37F	Parallel printer port 1 (LPT 2)
380-38F	SDLC, bisynchronous 2
3A0-3AF	Bisynchronous 1
3B0-3BF	Monochrome display and printer adapter (LPT1)
3C0-3CF	Reserved
3D0-3DF	Color/graphics monitor adapter
3E8-3EF	Reserved (Series port 3)
3F0-3F7	Diskette controller

Table C.1: System I/O ports

Addr. range (Hex)	Device
3F8-3FF	Serial port 1
* PNP audio I/O map range from 220 ~ 250H (16 bytes)	
MPU-401 select from 300 ~ 330H (2 bytes)	

C.2 1st MB memory map

Table C.2: 1st MB memory map

Addr. range (Hex)	Device
F0000h - FFFFFh	System ROM
*CC000h - EFFFFh	Unused (reserved for Ethernet ROM)
C0000h - CBFFFh	Expansion ROM (for VGA BIOS)
B8000h - BFFFFh	CGA/EGA/VGA text
B0000h - B7FFFh	Unused
A0000h - AFFFFh	EGA/VGA graphics
00000h - 9FFFFh	Base memory
* If Ethernet boot ROM is disabled (Ethernet ROM occupies about 16 KB)	
* E0000 - EFFFF is reserved for BIOS POST	

C.3 DMA channel assignments

Table C.3: DMA channel assignments

Channel	Function
0	Available
1	Available (audio)
2	Floppy disk (8-bit transfer)
3	Available (parallel port)
4	Cascade for DMA controller 1
5	Available
6	Available
7	Available

* Audio DMA select 1, 3, or 5

** Parallel port DMA select 1 (LPT2) or 3 (LPT1)

C.4 Interrupt assignments

Table C.4: Interrupt assignments

Interrupt#	Interrupt source
IRQ 0	Interval timer
IRQ 1	Keyboard
IRQ 2	Interrupt from controller 2 (cascade)
IRQ 3	COM2
IRQ 4	COM1
IRQ 5	Reserved (COM4)
IRQ 6	FDD
IRQ 7	LPT1
IRQ 8	RTC
IRQ 9	Reserved (audio)
IRQ 10	Reserved (COM3)
IRQ 11	Reserved for watchdog timer
IRQ 12	PS/2 mouse
IRQ 13	INT from co-processor
IRQ 14	Primary IDE
IRQ 15	Secondary IDE for CFC

* Ethernet interface IRQ select: 9, 11, 15

* PNP audio IRQ select: 9, 11, 15

* PNP USB IRQ select: 9, 11, 15

* PNP ACPI IRQ select: 9, 11, 15

Appendix

D

AT/ATX Power setting

Appendix D AT/ATX Power setting

D.1 Introduction

PCM-9387 supports 2 kinds of power mode to boot up system. One is ATX mode, the other is AT mode. ATX should connect standby power and power supply on# signal to turn on main power supply. AT power does not have those two pins and the pin 6 of PCM-9387 power connector (CN3) needs to be connected to 5 voltage for properly boot up.

The power connector table & Power supply diagram tables are as bellow:

Table D.1: Power Connector

Power Connector (CN3)	Power Type: ATX	Power Type: AT
Pin 1: GND	GND	GND
Pin 2: GND	GND	GND
Pin 3: VCC	+5V	+5V
Pin 4: GND	GND	GND
Pin 5: VCC	+5V	+5V
Pin 6:VCCSB	Standby +5V	+5V
Pin 7: GND	GND	GND
Pin 8: PWR_PSON#	PWR_PSON#	NC
Pin 9: VCC	+5V	+5V
Pin 10: GND	GND	GND
Pin 11: VCC	+5V	+5V
Pin 12: +12V	+12V(Optional)	+12V(Optional)

ATX power supply diagram

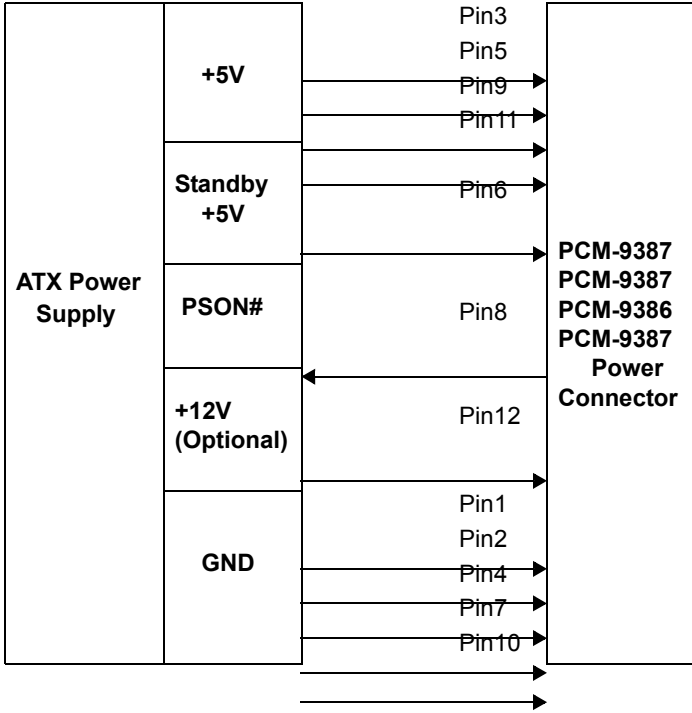

AT power supply diagram

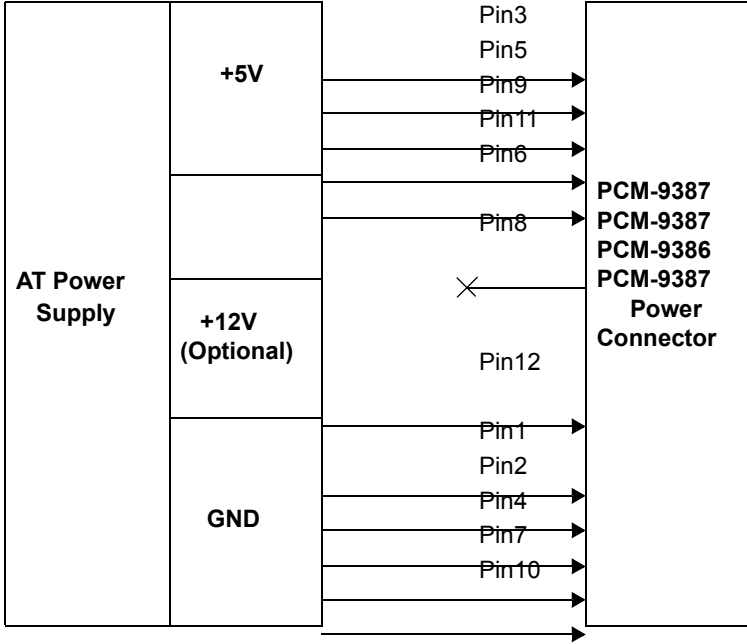

Appendix

E

Optional Kit

Appendix E Optional Kit

E.1 Embedded OS

- 2070000584 Win CE 4.2 P-M Core Image, PCM-938x, 2 COM, English, V1.10 (17.2MB) (Optional)
- 2070000585 Win CE 4.2 P-M Pro Image, PCM-938x, 2 COM, English, V1.10 (29.1MB) (Optional)
- 2070000586 Win CE 4.2 P-M Plus Image, PCM-938x, 2 COM, English, V1.10 (29.9MB) (Optional)
- 2070000765 Image CE 5.0 Pro Plus EN for P-M with 2COM
- 2070000605 Win XPE SP2 Image, PCM-938x, English, V2.10, (440MB), (Optional)

E.2 Optional Kit

- 1700000410 CABLE DVI-26P/DF13-20P 20cm
- 1700002532 FLAT cable 14P/5P for internal COM1 RS-232 20cm
- 1700002595 PCI to ISA bridge connector (for PC/104 module)

E.3 Assembly for CPU and cooling for PCM-9380, uFCPGA type CPU, please follow the following assembly information

Product Part Number:

PCM-9380F-00A1(E); PCM-9380F-00A2E

PCM-9380FG-00A1(E);PCM-9380FG-00A2E

PCM-9381F-00A1(E);PCM-9381F-00A2E

PCM-9381FG-00A1(E);PCM-9381FG-00A2E

CPU type: uFCPGA

Cooling Part number: 1750000287

This cooling heatsink is designed for both PCM-9380 and PCM-9381.

While stacking the PCI-104 module or MIO module, you need to remove the unnecessary spacer as below:

- 1.For the PCM9380 series, the left spacer should be removed.
- 2.For the PCM9381 series, the right spacer should be removed.



Appendix

F

Mechanical Drawings

Appendix F Mechanical Drawings

F.1 Mechanical Drawings

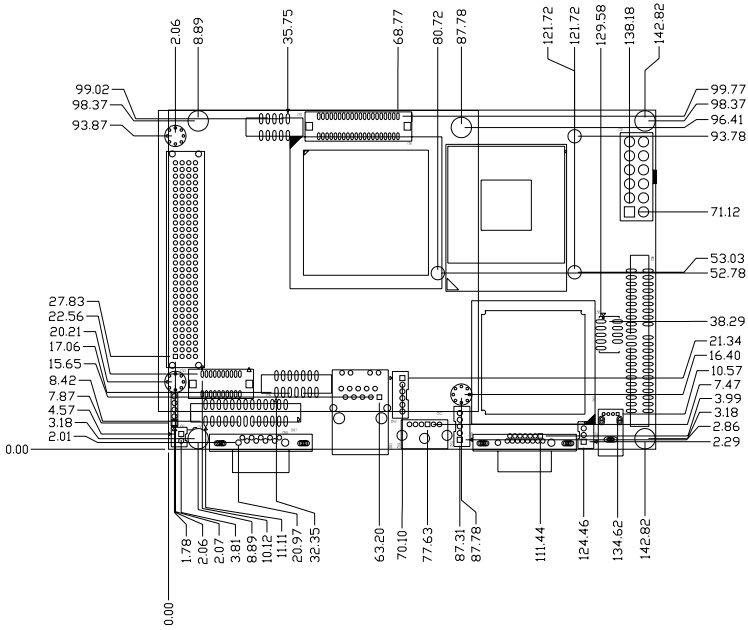

Figure F.1: PCM-9387 Mech Drawing (Component)

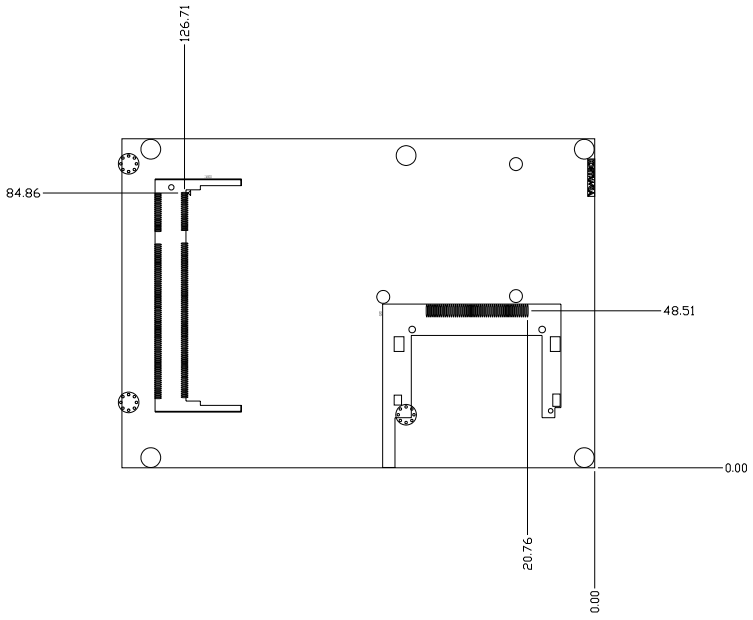

Figure F.2: PCM-9387 Mech Drawing (Solder Side)

